

## Operating and Assembly Instructions

Please read and save these instructions. Read carefully before attempting to assemble, install, operate or maintain the product described. Protect yourself and others by observing all safety information. Failure to comply with instructions could result in personal injury and/or property damage! Retain instructions for future reference.



# Airless Paint Sprayers

For questions, parts and accessories: 1-800-626-4401



Models PS120B

# Airless Paint Sprayers

## Table of Contents

Description . . . . .	2
Application Chart . . . . .	2
Safety Guidelines . . . . .	3
General Safety Information . . . . .	3
Assembly Instructions . . . . .	6
Preparation . . . . .	6
Spraying Instructions . . . . .	8
Cleanup . . . . .	10
Storage . . . . .	14
Spray Gun Maintenance . . . . .	15
Maintenance Chart . . . . .	16
Specifications . . . . .	17
Replacement Parts . . . . .	18
Troubleshooting . . . . .	20
Force Feeding Pump . . . . .	22
Warranty . . . . .	24

## Description

Airless paint sprayers are capable of spraying a wide variety of latex, oil-based, and alkyd paints, as well as stains, preservatives and other non-abrasive finishes.

These sprayers are also powerful and versatile enough to be used with a variety of options (roller attachment, extra lengths of hose, etc.) to make it an even more efficient tool.

**NOTE:** Guns pictured in illustrations may be different than the one included with your unit.

## Application Chart

Coating	Can Use	Do Not Use	Tip Size	Spray Pressure
Oil Base Stain	x		.011 - .013"	800 + psi
Wood Sealer	x		.011 - .013"	800 + psi
Concrete Sealer	x		.011 - .013"	800 + psi
Enamel	x		.011 - .013"	1500 + psi
Varnish	x		.011 - .015"	1500 + psi
Non-Metal Flake Aluminum Paint	x		.011 - .015"	1500 + psi
Vinyl Latex Paint	x		.013 - .015"	1700 + psi
Vinyl / Acrylic Latex Paint	x		.013 - .015"	1700 + psi
Acrylic Latex Paint	x		.013 - .015"	1700 + psi
Oil Base Paint	x		.013 - .015"	1700 + psi
Oil and Water Based Primer	x		.013 - .015"	1700 + psi
V. V/A & A Latex Stain	x		.013"	1700 + psi
Textured Coatings		x	N/A	
Elastomerics		x	N/A	
Asphalt Coating		x	N/A	
Wood Restorer		x	N/A	
Block Filler		x	N/A	
All Other Materials Not Listed - Call Technical Support at 1-800-626-4401.				

# Airless Paint Sprayers

## Safety Guidelines

### IMPORTANT SAFETY INSTRUCTIONS SAVE THESE INSTRUCTIONS

This manual contains information that is very important to know and understand. This information is provided for SAFETY and to PREVENT EQUIPMENT PROBLEMS. To help recognize this information, observe the following symbols.

**⚠ DANGER** *Danger indicates an imminently hazardous situation which, if not avoided, WILL result in death or serious injury.*

**⚠ WARNING** *Warning indicates a potentially hazardous situation which, if not avoided, COULD result in death or serious injury.*

**⚠ CAUTION** *Caution indicates a potentially hazardous situation which, if not avoided, MAY result in minor or moderate injury.*

**NOTICE** *Notice indicates important information, that if not followed, MAY cause damage to equipment.*

### Unpacking

After unpacking the unit, inspect carefully for any damage that may have occurred during transit. Make sure to tighten fittings, bolts, etc., before putting unit into service.

**⚠ WARNING** *Do not operate unit if damaged during shipping, handling or use. Damage may result in bursting and cause injury or property damage.*

### General Safety Information

#### CALIFORNIA PROPOSITION 65

**⚠ WARNING** *This product or its power cord may contain chemicals, including lead, known to the State of California to cause cancer and birth defects or other reproductive harm. Wash hands after handling.*

### GENERAL SAFETY

1. SAVE THESE INSTRUCTIONS - To reduce the risks of fire or explosion, electrical shock, and injury to persons, read and understand all instructions included in this manual. Be thoroughly familiar with the controls and the proper use of the equipment.



2. Always wear a mask or respirator and eye protection when painting. Be certain mask or respirator will provide necessary protection against inhalation of harmful vapors.



3. Keep visitors away and NEVER allow children or pets in the work area.
4. Do not smoke or eat when spraying paint, insecticides, or other flammable substances.
5. Always work in a clean environment. To avoid injury and damage to the workpiece, do not aim the spray gun at any dust or debris.
6. When spraying and cleaning, always follow the instructions and safety precautions provided by the material manufacturer (Refer to MSDS).

### ⚠ DANGER

#### ELECTRICAL SHOCK HAZARD:

- Follow all local electrical and safety codes, as well as the National Electrical Code (NEC) and in the United States, the Occupational Safety and Health Act (OSHA).
- This product must be grounded. In the event of an electrical short circuit, grounding reduces the risk of electric shock by providing an

escape wire for the electric current. This product is equipped with a cord having a grounding wire with an appropriate grounding plug. The plug must be plugged into an outlet that is properly installed and grounded in accordance with all local codes and ordinances.

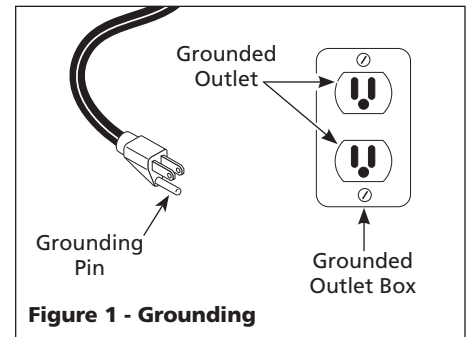

Figure 1 - Grounding

**⚠ WARNING** *Improper installation of the grounding plug is able to result in a risk of electric shock.*

- When repair or replacement of the cord or plug is required, do not connect the grounding wire to either flat blade terminal. The wire with insulation having an outer surface that is green with or without yellow stripes is the grounding wire.
- Check with a qualified electrician or serviceman when the grounding instructions are not completely understood, or when in doubt as to whether the product is properly grounded. Do not modify the plug provided; if it does not fit the outlet, have the proper outlet installed by a qualified electrician.
- This product is for use on a nominal 120V circuit and has a grounding plug similar to the plug illustrated in Figure 1. Only connect the product to an outlet having the same configuration as the plug. Do not use an adapter with this product.

# Airless Paint Sprayers

- Only qualified electricians or service personnel should perform maintenance on the electrical components of this equipment.

- Do not modify any of the electrical components of this equipment.



- If using an extension cord, use only grounded three wire extension cords that are in good condition.

### APPROPRIATE EXTENSION CORD GAUGE FOR GIVEN LENGTHS

Length of Cord	Gauge
25'	14
25-50'	12
50-100'	10

### ⚠ WARNING

#### SKIN INJECTION HAZARD:

- High pressure spray can inject toxins into blood stream. If injection occurs, seek emergency medical treatment.

### ⚠ WARNING

Use a

**face mask/respirator and protective clothing when spraying. Always spray in a well ventilated area to prevent health and fire hazards. Refer to Material Safety Data Sheets (MSDS) of spray material for details.**



- Never try to stop leaks with any part of your body.
- This system is capable of producing 2800 psi (19 300 kPa). Use only Campbell Hausfeld replacement parts rated at 2800 psi (19 300 kPa) or higher.

### ⚠ WARNING

**To reduce the risk of skin injection:**



- Do not aim the gun at, or spray, any person or animal.
- Keep hands and other body parts away from the discharge. For example, do not try to stop leaks with any part of the body.
- Do not clean spray tip while it is attached to the spray gun. Remove spray tip from gun to clean tip guard.
- Always use the nozzle tip guard. Do not spray without nozzle tip guard in place.
- Do not remove tip while cleaning the pump.
- Only use a nozzle tip specified by the manufacturer.
- Use caution when cleaning and changing nozzle tips. Before removing the nozzle tip, follow the manufacturer's instructions for turning off the unit and relieving the pressure.
- Do not leave the unit energized or under pressure while unattended. When not in use turn off the unit and relieve the pressure in accordance with the manufacturer's instructions.

- High pressure spray is able to inject toxins into the body and cause serious bodily injury. In the event that injection occurs, seek medical attention immediately.
- Check parts for signs of damage. Replace any damaged parts.
- This spray gun is rated for 3000 psi (20 500 kPa). Do not use on systems designed to produce more than 3000 psi (20 500 kPa).
- Always engage the trigger lock when not spraying. Verify the trigger lock is functioning properly.
  - To lock (engage): rotate tabs on lock to horizontal position.
  - To unlock (disengage) to spray: rotate tabs on lock to vertical position.

**NOTE:** If gun sprays while in the locked position follow instructions in Spray Gun Maintenance section for trigger lock.

- Verify that all connections are secure before operating. Do not use pliers to tighten or loosen high pressure connections.
- Know how to stop your unit and bleed pressure quickly. Be thoroughly familiar with the controls.

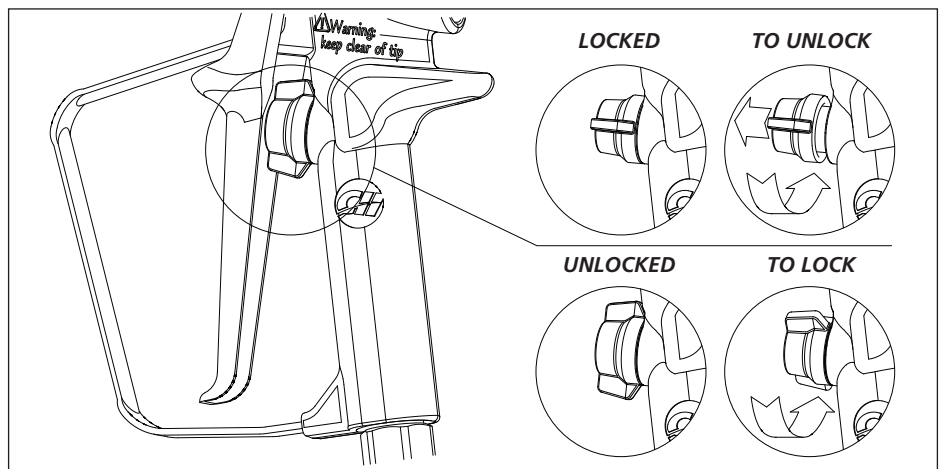

# Airless Paint Sprayers

- Motor is equipped with an automatic thermal overload. Motor will restart without warning, after cooling.

**⚠ WARNING** *Never aim or spray at yourself or anyone else or serious injury could occur.*

**Relieve pressure before servicing or resting:**

1. Turn the Prime/Spray Control to the PRIME position.
  2. Turn the pressure control knob to LOW PRESSURE position (CCW).
  3. Turn power switch to OFF position and unplug the power cord.
  4. With gun pointed in a safe direction, pull the gun trigger, with the trigger lock disengaged.
  5. Engage trigger lock.
- Simply turning off the pump motor will not relieve pressure from system. The above procedure **MUST** be followed.

**⚠ WARNING**

**FIRE OR EXPLOSION HAZARD:**

- Do not use solvents with flash points less than 70°F (21°C) to clean this equipment (examples of acceptable cleaning solvents are water or mineral spirits. A partial example list of unacceptable cleaning solvents are low flash napha, mek, acetone, alcohol and toluene).
- Use only conductive or grounded high-pressure airless paint sprayer hoses specified by the manufacturer.
- Verify that all containers and collection systems are grounded to prevent static discharge.
- Do not spray pump assembly.
- Have fire extinguisher equipment present and working.

**⚠ WARNING** *Do not spray*

**flammable materials in vicinity of open flame or near ignition sources. Motors, electrical equipment and controls can cause electrical arcs that will ignite a flammable gas or vapor. Never store flammable liquids or gases in the vicinity of the unit.**



**⚠ WARNING** *Do not spray acids, corrosive materials, toxic chemicals, fertilizers or pesticides. Using these materials could result in death or serious injury.*

- Do not use fuels to clean this equipment.
- Keep spray area well ventilated. Keep a good supply of fresh air moving through the spray area. Keep pump assembly in well ventilated area.
- Remove all ignition sources (i.e. Static electricity, pilot lights, cigarettes and electrical arcing).
- Airless spraying can cause static electricity. Always ground the pump and spraying surface. Always use a 3-wire grounded extension cord and power receptacle. Do not use 3 to 2 adapters.
- Do not use paints or solvents containing halogenated hydrocarbons such as methyl bromine, carbon tetrachloride, and ethyl iodine.

**⚠ CAUTION** *Keep hose away from sharp objects.*

**Bursting hoses may cause injury. Examine hoses regularly and replace if damaged.**

- Check hoses for weak or worn condition before each use, making certain that all connections are secure.
- Keep area clean and free of paint or solvent containers, rags, and other flammable materials.

**⚠ WARNING**

**TO REDUCE THE RISK OF INJURY:**

- Do not spray acids, corrosive materials, toxic chemicals, fertilizers, or pesticides. Using these materials could result in death or serious injury.
- Do not kink or over-bend the hose.
- Do not expose the hose to temperatures or to pressures in excess of those specified by the manufacturer.
- Do not use the hose as a strength member to pull or lift the equipment.
- Always wear appropriate gloves, eye protection, and a respirator or mask when painting.
- Always work in a clean environment. Do not aim the spray gun at any dust or debris.
- Do not operate or spray near children. Keep children, pets, and visitors away from equipment and work area at all times.
- Do not over reach or stand on an unstable support. Keep effective footing and balance at all times.
- Stay alert and watch what you are doing.
- Do not operate the equipment when fatigued or under the influence of drugs or alcohol.



**FAILURE TO FOLLOW THESE INSTRUCTIONS CAN RESULT IN SERIOUS INJURY INCLUDING DEATH.**

# Airless Paint Sprayers

## Assembly Instructions

### TOOLS REQUIRED:

- ◆ 3/4 in. or Adjustable Wrench
- ◆ 5/8 in. or Adjustable Wrench

### ASSEMBLY

1. Open packaging and check contents.
2. Remove the equipment and all parts from the carton.
3. Attach high pressure hose to pump and spray gun using a 3/4 inch wrench (See Figure Below).

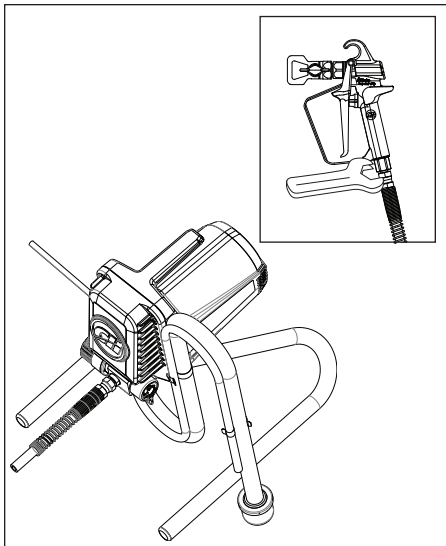
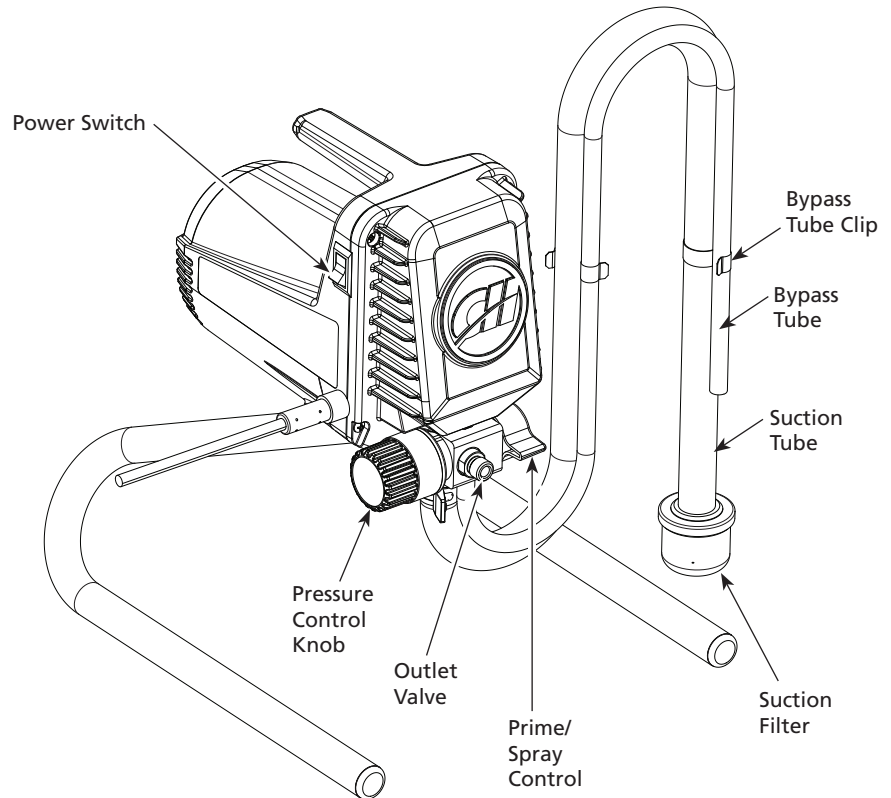

Figure - Attach hose

## Pump Assembly



## Preparation

Airless painting systems, unlike most other power tools, require additional care to ensure proper working order. Following these instructions will significantly increase the likelihood of having a positive paint experience. **It is important that the painting equipment is flush/tested EACH time a new job is started.** Each pump is tested at the factory with a fluid that must be flushed from the

system prior to painting. It is also required prior to each successive use to flush the storage lubricant from the system. Flush the system with either water or mineral spirits. Use water if spraying water based coatings or use mineral spirits if spraying oil based coatings.

# Airless Paint Sprayers

## Preparation (Continued)

1. Place both suction and bypass tubes in cleaning solvent.
2. Turn prime/spray control to the PRIME position.
3. Turn power switch to the ON position.
4. Turn pressure to HIGH (completely clockwise). In a few seconds, cleaning solvent will begin to move up through the tube. Allow the fluid to circulate for one minute to ensure all air has been exhausted from the pump.
5. Turn prime/spray control to SPRAY position. Watch for any fluid leaks (See Troubleshooting Chart if leaks occur).

**NOTE:** If unit is building pressure properly the pump should turn off, which indicates it has reached its user set pressure.

6. When flushing the system with cleansing fluid (either prior to use with paint or during cleaning process) the spray tip can remain in the CLEAN position.
7. Point spray gun into an empty waste bucket and pull trigger. To reduce splashing, direct the fluid stream along the inside of the bucket wall and well above the fluid level.

## Starting Instructions

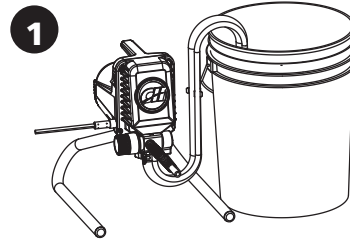

1  
Place Suction Tube and Bypass Tube in Solvent

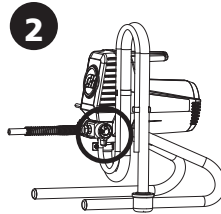

2  
Turn Prime/ Spray Control to PRIME (knob is vertical)

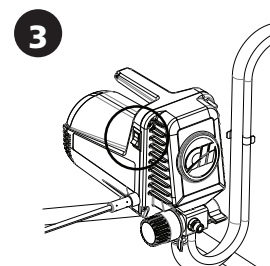

3  
Power Switch Location

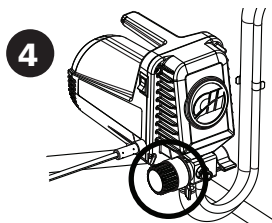

4  
Turn Pressure to HIGH (completely clockwise)

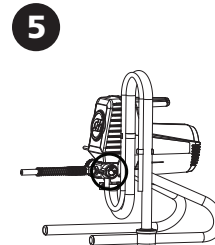

5  
Turn Prime/ Spray Control to SPRAY (knob is horizontal)

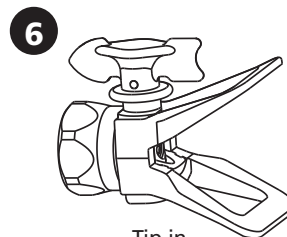

6  
Tip in CLEANING Position



7  
While Pulling Trigger, Direct Fluid Stream Along Inside of Bucket

# Airless Paint Sprayers

## Preparation (Continued)

9. After completing the flush/testing process, purge the pump of fluid.
10. Repeat the preceding steps using paint instead of cleaning solvent.

**NOTE:** Strain and thin paint before using. All paint may have particles that will clog filter and spray tips. Remove any skin which may have developed on

the paint due to air exposure. Follow paint manufacturers' recommendations on thinning paint.

11. When pure paint appears from spray tip rotate tip to the SPRAY position. The system is now ready for use.

## Spraying Instructions

Professional looking results can be obtained by following the spray tips below.

1. Keep the gun perpendicular to the surface.

Always hold the gun perpendicular to the surface with the tip approximately 12 inches from the surface. If held at an angle (up and down or side to side), paint will build up unevenly, leave the work splotchy, and cause excessive overspray (See Figure to the right).

2. Move with a smooth arm stroke.

Move the gun at a steady, even pace while keeping the gun perpendicular to the surface (See Figures to the right). Do not fan the gun. Fanning the gun will cause excessive overspray and uneven coverage (See Figure to the right).

3. Start moving the gun before triggering.

To get a smooth overlap and prevent initial paint buildup, start your stroke movement before pulling the trigger. Release the trigger before stopping at the end of the stroke (See Figure to the right).

**NOTE:** To assure uniform paint coverage, overlap each stroke by 20% - 30% and use two coats with a cross pattern (one coat horizontal, second coat vertical).

12"

Holding Spray Gun

Thin Coat Heavy Coat Thin Coat

Over-spray Over-spray

**INCORRECT**

Result of Flexing Wrist While Spraying

Approx. 10-12"

Pull Trigger Release Trigger

Start Stroke End Stroke

Proper Way to Trigger Spray Gun

**1**

CLEAN Position

**2**

SPRAY Position

Water

Prevent clogged tip



# Airless Paint Sprayers

## Spraying Instructions (Continued)

### INTERMITTENT USE

If you are spraying and decide to stop for several minutes, lock the spray gun trigger and submerge the tip in a container of water (See Figure on page 8). This will prevent paint from hardening in the tiny spray opening and clogging the tip. **Be sure to release the pressure in the system and turn the unit off.**

### CLEARING CLOGS

#### REVERSIBLE TIP: (INCLUDED)

1. Rotate the tip to the CLEAN position (See Figure 1 on page 8).
2. Point gun in a safe direction and spray. This should clear tip of any blockage.
3. Rotate the tip back to the SPRAY position and continue spraying (See Figure 2 on page 8).
4. If clogging continues, replace gun filter and consider straining the paint prior to use.

#### NOTICE

**Equipment damage can occur if a needle or sharp object is used to clean the tip. Tungsten carbide is brittle and can be chipped.**

### HOW TO CHANGE SPRAY TIPS

It may be necessary to change spray tips during a paint job. Follow these steps for safe, easy tip changes.

1. Depressurize and turn off unit per manufacturer's instructions.
2. Engage gun trigger lock.
3. Pull red tip insert out of spray base and replace with different tip, fully inserting tip into base.

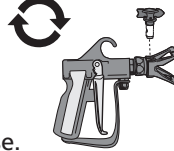

### HOW TO ATTACH ROLLER ACCESSORY

1. Depressurize and turn off unit per manufacturer's instructions.
2. Engage gun trigger lock.
3. Remove spray base, tip, seal and washer assembly.
4. Attach roller accessory (AL2275 shown) to airless spray gun. If needed use thread adapter and washer between roller and spray gun as shown.

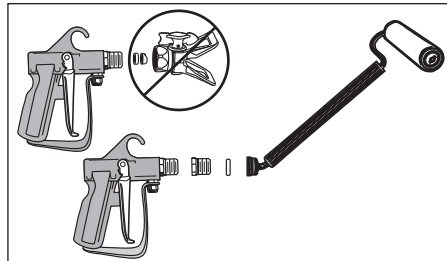

Figure - Attach roller accessory to spray gun

# Airless Paint Sprayers

## Cleanup

### CLEANUP FOR OVERNIGHT STORAGE

**NOTE:** Cleaning and maintenance of the pump are the most important steps you can take to ensure proper operation and a long life for your airless paint sprayer. Please follow the cleaning instructions carefully and . . .

#### WEAR ALL NECESSARY SAFETY GEAR

#### NECESSARY TOOLS / MATERIALS:

- One (1) bucket
- Water
- Plastic wrap

#### NOTICE

*When reusing the sprayer with the*

***SAME PAINT the next day at the SAME JOB SITE, it is not necessary to flush the paint from the system. However, IT IS IMPORTANT TO KEEP AIR FROM COMING INTO CONTACT WITH THE PAINT.***

**NOTE:** Do NOT disconnect any hoses.

1. Turn prime/spray control to PRIME position.

**CAUTION** *High pressure hose may still be pressurized with prime/spray control in the PRIME position. With the gun pointed in a safe direction, pull the gun trigger to relieve any pressure in the hose.*

2. Engage gun trigger lock.
3. Place spray gun in bucket of water. There should be enough water to COVER spray tip. This will prevent paint from drying or clogging tip.
4. Leave suction and bypass tubes in bucket of paint. Make sure ends of suction and bypass tubes are BELOW surface of paint in bucket.
5. Cover bucket and tubes with plastic wrap or a damp towel to prevent film forming on paint. Or, if using latex paint, pour a very thin layer of water over top of paint. Stir water into paint the next morning.

## Temporary Cleanup

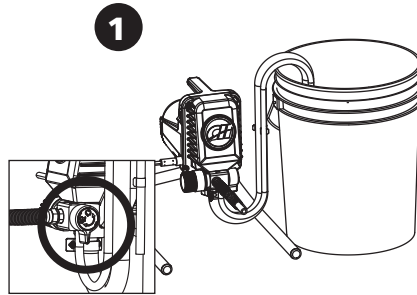

Turn Prime/Spray Control to PRIME Position

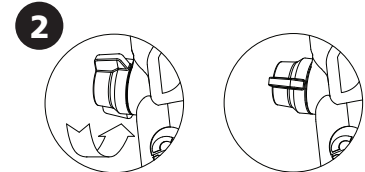

Engage Trigger Lock

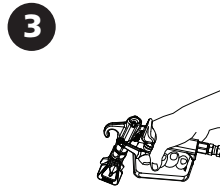

Place Gun in Water

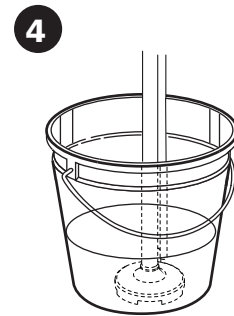

Suction and Bypass Tubes Remain in Bucket with Ends Below Paint Surface

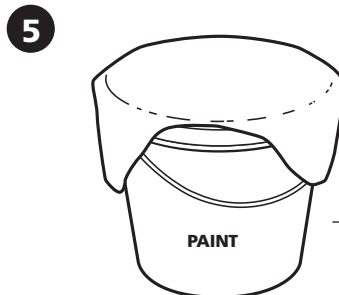

Cover Bucket

or



Latex Paint: Use Thin Layer of Water to Cover Paint

# Airless Paint Sprayers

## CLEANUP FOR CHANGING PAINTS OR TEMPORARY STORAGE FOR MORE THAN ONE NIGHT

### WEAR ALL NECESSARY SAFETY GEAR

#### NECESSARY TOOLS / MATERIALS:

- Rag
- Gloves
- Two (2) buckets
- At least one (1) gallon of cleaning fluid (water or mineral spirits depending on coating type)
- Cleaning brush

**NOTE:** Do NOT disconnect any hoses.

1. Turn prime/spray control to PRIME position.
2. Turn power switch to ON.

**CAUTION** *High pressure hose may still be pressurized with prime/spray control in the PRIME position. With the gun pointed in a safe direction, pull the gun trigger to relieve any pressure in the hose.*

3. Turn pressure to HIGH (completely clockwise).
4. Lift suction assembly above fluid level in bucket.  
While holding suction assembly above paint level, allow pump to run until empty.
5. Immediately place both suction assembly and bypass tube in a bucket containing enough cleaning fluid to cover suction filter by two inches. Allow pump to prime and begin circulating fluid.
6. While fluid is circulating, soak rag in fluid and wipe exterior of suction assembly and bypass tube. Remove suction filter. Wipe suction filter with rag removing excess paint buildup. Reinsert filter into suction tube.

## Cleaning Pump

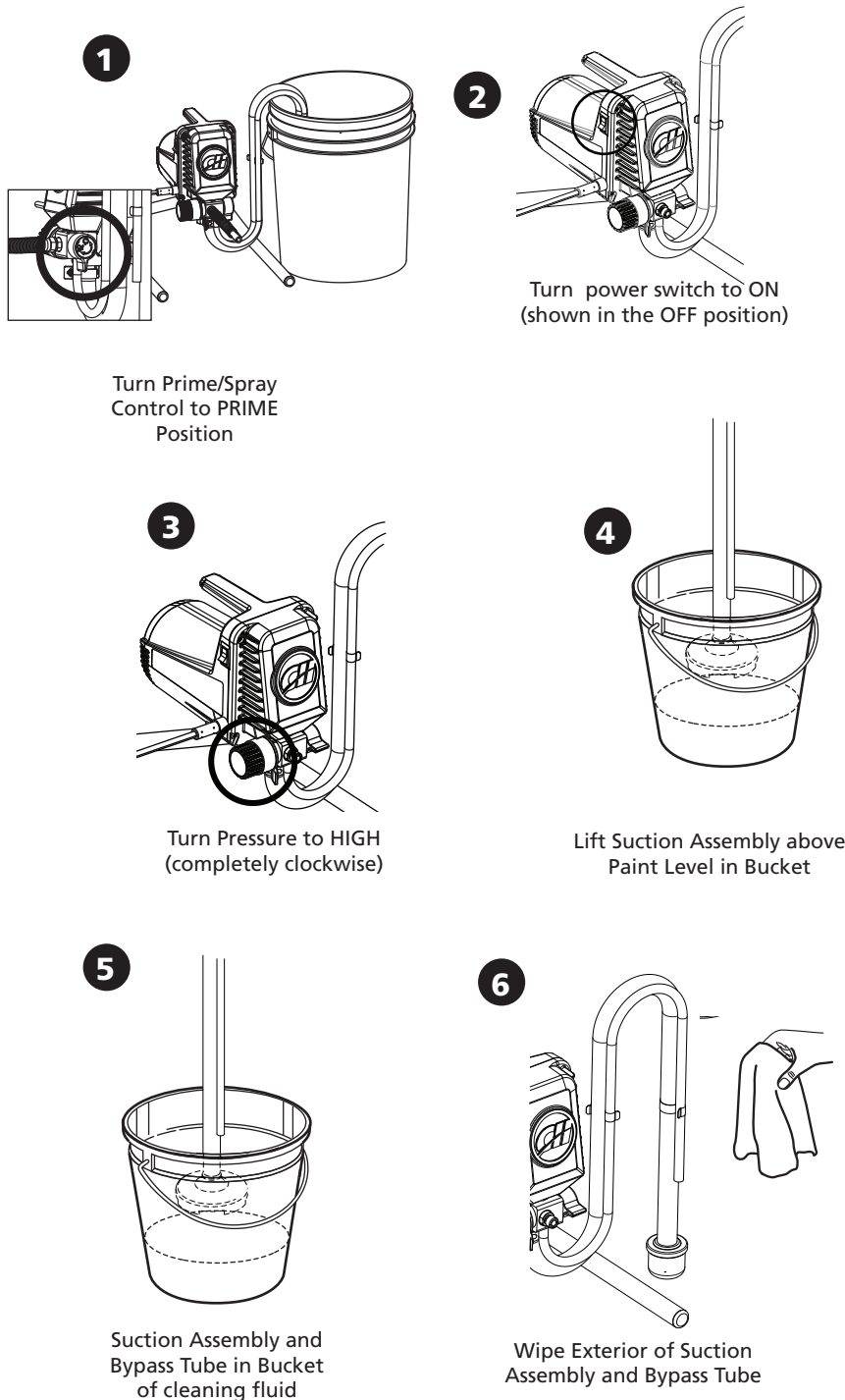

# Airless Paint Sprayers

## CLEANUP FOR CHANGING PAINTS OR TEMPORARY STORAGE FOR MORE THAN ONE NIGHT (Continued)

Allow the cleaning fluid to continue circulating for approximately 10 minutes.

7. Turn pressure to HIGH (completely clockwise).
8. Turn prime/spray control to SPRAY position.
9. Rotate spray tip to CLEAN position.
10. Point spray gun into bucket of paint and pull trigger.

**NOTE:** To reduce splashing, direct fluid stream along inside of bucket and above the paint level.

11. As soon as cleaning fluid is flowing from spray gun, release trigger.

**NOTE:** It should take less than one minute to clear each 25 feet of high pressure hose.

12. Engage gun trigger lock.
13. Turn prime/spray control to PRIME position.
14. Turn pressure control to HIGH.
15. Lift suction assembly above fluid level in bucket.

**NOTE:** Allow pump to run until empty.

16. Repeat process (1 - 15) with fresh cleaning fluid, to remove contaminated cleaning fluid from initial cleaning.

## Cleaning Hose and Gun

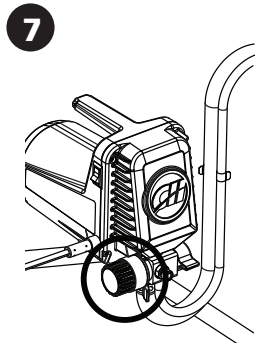

Turn Pressure to HIGH (completely clockwise).

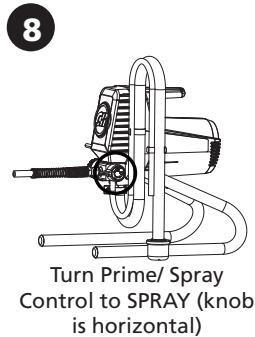

Turn Prime/ Spray Control to SPRAY (knob is horizontal)

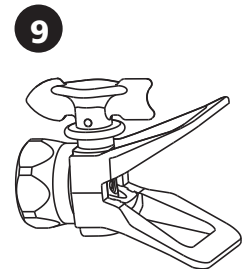

If Reversible Tip is Used, Rotate Spray Tip to CLEAN Position.

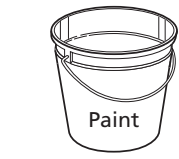
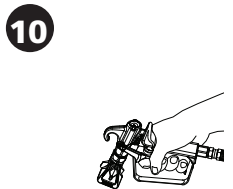

While Pulling Trigger, Direct Fluid Stream Along Inside of Bucket

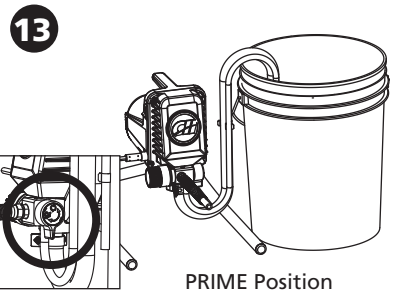
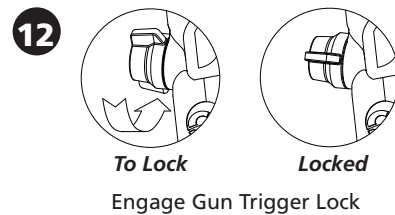

PRIME Position

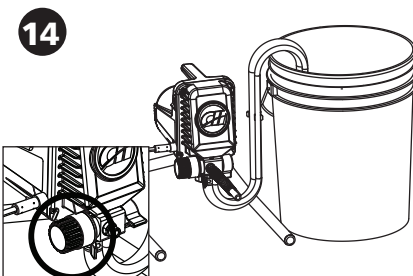

HIGH PRESSURE Position (completely clockwise)

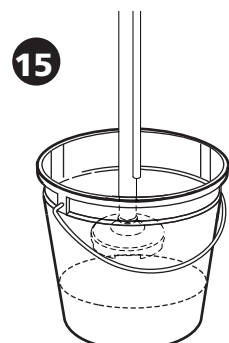

Lift Suction Assembly

# Airless Paint Sprayers

## CLEANUP FOR CHANGING PAINTS OR TEMPORARY STORAGE FOR MORE THAN ONE NIGHT (Continued)

17. Make sure prime/spray control is in SPRAY position to reduce dribbling.
18. Turn pressure to LOW (completely counterclockwise).
19. Turn power switch to OFF position.
20. With gun pointed in safe direction pull trigger with lock released to relieve any pressure in hose.
21. Engage gun trigger lock.
22. Clean buckets and dispose of any waste paint and cleaning fluid in an environmentally responsible manner.
23. Clean tip guard with cleaning brush and cleaning fluid.

**NOTE:** At this point, pump, hose and spray gun are clean, but still require further preparation for storage of more than one day.

## Finishing Touches/Shutdown

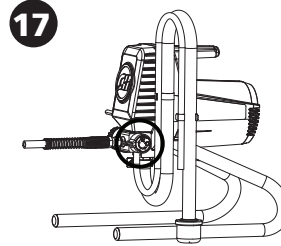

17  
Prime/Spray is in SPRAY Position

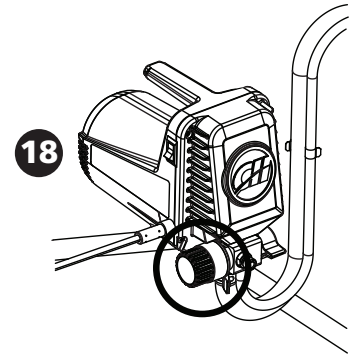

18  
Turn Pressure to LOW (completely counterclockwise)

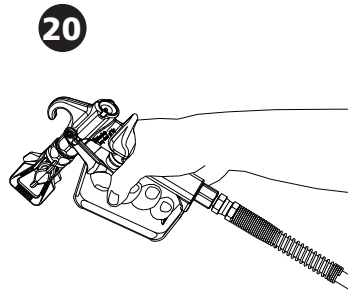

20  
Pull Gun Trigger with Trigger Lock Released

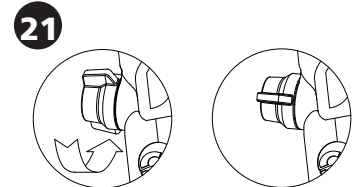

21  
To Lock Locked  
Engage Gun Trigger Lock

# Airless Paint Sprayers

## Storage

### SHORT TERM (LESS THAN ONE WEEK)

**WEAR ALL NECESSARY  
SAFETY GEAR**

#### NECESSARY TOOLS / MATERIALS:

- Pump Protector Solution
- Plastic Wrap
- 3/4 in. or Adjustable Wrench

#### OIL OR ALKYD BASED PAINT

If sprayer cleaned with mineral spirits, simply wrap suction filter housing in plastic to keep debris out of suction filter. No other preparation is necessary.

#### WATER-BASED PAINT

1. Prepare Pump Protector solution in bucket as directed on container.
2. Place suction assembly into solution.
3. Place end of bypass tube into waste bucket.
4. With prime/spray control in PRIME position, turn pressure to HIGH (completely clockwise).
5. Turn power switch ON. Circulate Pump Protector through bypass tube until bucket of solution is EMPTY.
6. Turn pressure to LOW (completely counterclockwise).
7. Wrap suction filter housing in plastic to keep debris out of suction filter.

### LONG TERM (MORE THAN ONE WEEK)

8. Remove high pressure hose and drain. Reassemble high pressure hose to pump.
9. With spray tip attached to spray gun, wrap tip with plastic to protect tip.

## Water Based Paint

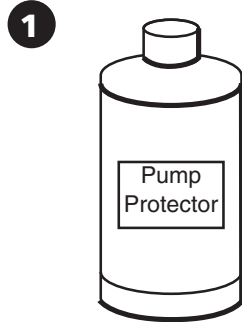

Prepare Pump Protector Solution

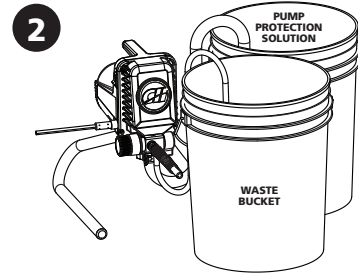

Place Suction Assembly in Solution

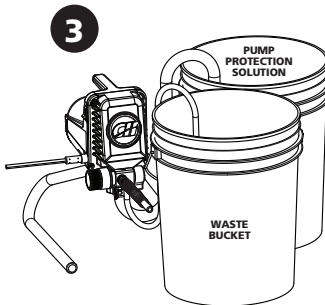

Place End of Bypass Tube into Waste Bucket

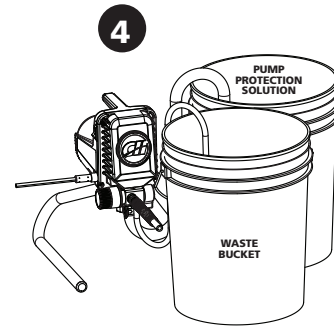

With Prime/Spray Control in PRIME Position, Turn Pressure to HIGH (completely clockwise)

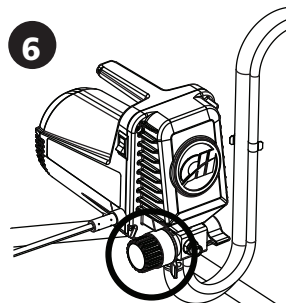

Turn Pressure to LOW (completely counterclockwise)

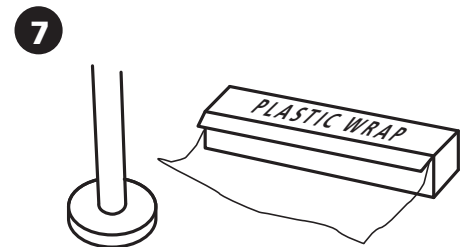

Wrap Suction Filter Housing in Plastic

# Airless Paint Sprayers

## Spray Gun Maintenance

### NOTICE

*Pump damage may occur if these instructions are not followed.*

### WARNING

*Before performing any maintenance, make sure to relieve pressure from system and disconnect power from sprayer.*

- Do not use oil based solvents to clean equipment after using latex based coatings. Use only warm soapy water.
- Always replace clogged gun filters, do not attempt to clean them.
- Carefully follow cleaning and storage instructions for your sprayer.
- Do not use metal or other hard objects to pick dried paint material from Spray Tip Orifice.

## TRIGGER LOCK

### WARNING

*Pulling the trigger must not open the gun valve when trigger lock is activated.*



You should be able to get the actuator (#12, page 19) to wiggle slightly with your finger while holding the trigger against the trigger lock when it is in the locked position. If you cannot, adjust the trigger position by following these instructions:

1. Place trigger in locked orientation (tabs horizontal).
2. With one hand holding trigger lightly against lock, use a 1/4 inch nut driver to turn nut (#13, page 19) in until trigger starts to come off the lock.
3. Reverse the nut (counterclockwise) 1/2 turn.

## TIP SEAL AND WASHER

Occasionally, you will need to replace the silver seal and clear washer located inside the tip base.

1. To replace seal and washer, first loosen tip base with adjustable wrench, and then remove by hand.
2. Remove spray tip.
3. With Phillips screwdriver, push seal and washer out from front of tip base.
4. With flat side of seal facing up, place seal in base. Make sure it lines up properly with base.
5. Place washer in base. Make sure it lines up properly with base.
6. Put spray tip back in tip base.
7. Reattach tip base to gun valve.

### WARNING

*Make sure spray tip and tip base fit snugly in place. A loose fit can lead to misdirected spray discharge and a skin injection hazard.*

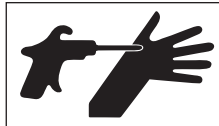

# Airless Paint Sprayers

## Maintenance Chart

Maintenance Item	Check	Replace	User Serviceable	Detail Notes
Product safety labels	Before each use	As required	Yes	Call for location of product safety labels and related part numbers.
Trigger adjustment	Before each use		Yes	See trigger lock warning under Spray Gun Maintenance.
Airless hose	Before each use		Yes	Read information on the hang tag attached to the high pressure hose for instructions on maintenance.
Sealing surfaces	Before each use		Yes	Make sure they are clean.
Suction tube	Before each use	As required	Yes	Check for nicks and cuts.
Bypass tube	Before each use	As required	Yes	Check for nicks and cuts.
Suction filter	Before each use and every 5 gal.	As required	Yes	
Gun filter	Before each use	Every 25 gal.	Yes	Do not attempt to clean gun filter, only replace.
Roller nap	Before each use and every 5 gal.	As required	Yes	
Pressure switch and prime/spray valve		Does not require replacement with normal use	* Call	
Inlet valve	Before each use		Yes	7/8" Wrench, torque to 150 in/lbs.
Outlet valve	Before each use		Yes	5/8" Wrench torque to 150 in./lbs.
Spray tip	Before each use	Every 20-75 gal.	Yes	1" Wrench torque to 135 in/lbs.

\* Call 1-800-626-4401



# Airless Paint Sprayers

## Specifications

Operating Pressure	Power Ratings	Safety Features
0-2800 psi	120 Volts AC 60 Hz 7,0 Amps	Spray gun trigger lock Spray gun trigger guard Spray gun pressure diffuser Prime/Spray valve over pressure relief

Model	Weight (lbs.)	Capacity (GPM)		Maximum Hose Length	Maximum Tip Size
		@ 0 psi	@ 2000 psi		
PS120B	14 lbs.	0.28	0.24	50 ft.	.015 in.

## For Replacement Parts and Accessories, Call 1-800-626-4401

Please provide following information:

- Model number
- Serial number (if any)
- Part descriptions and number as shown in parts list

Address parts correspondence to:

Campbell Hausfeld  
Attn: Customer Service  
100 Mundy Memorial Dr.  
Mt. Juliet, TN 37122 U.S.A.

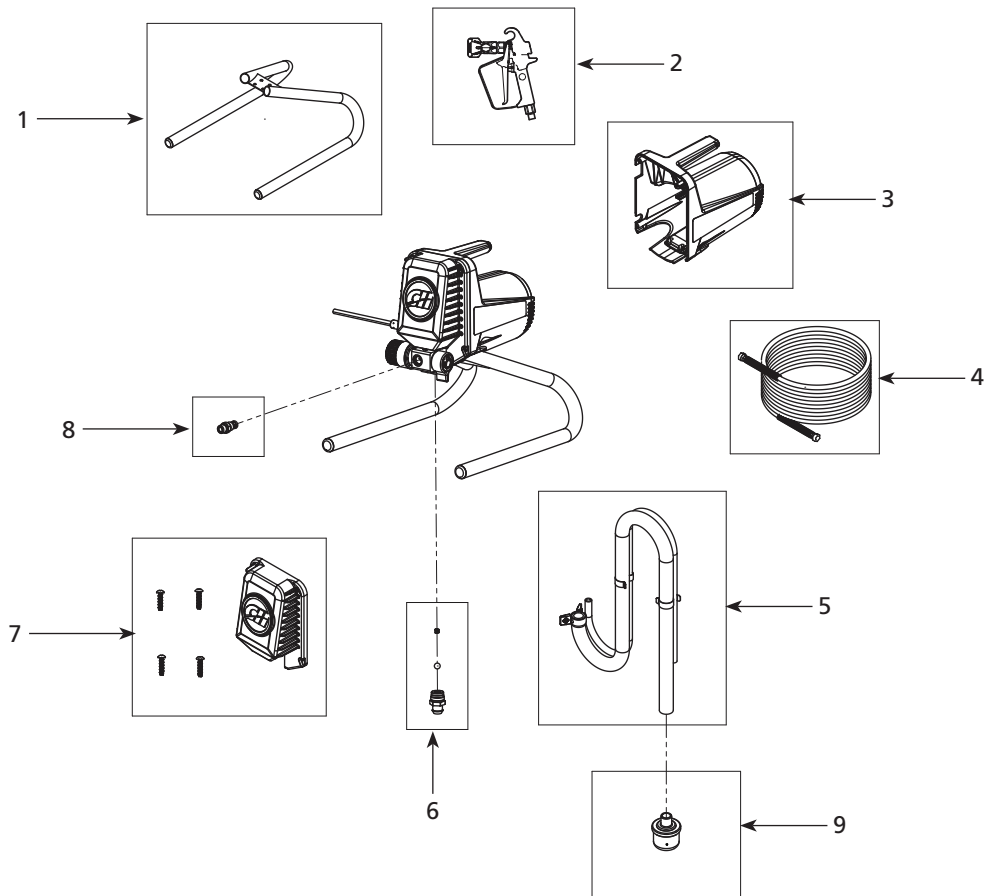

### Replacement Parts List

Ref No.	Description	Part No.	Qty.
1	Stand	AL168650SJ	1
2	Gun assembly (with 0.013" insert, tip)	AL2150	1
2a	0.013" Tip insert	AL2213	1
2b	0.015" Tip insert	AL2215	1
3	Motor cover with 2 decals	AL168620SJ	1
4	25' black hose	HA211301AV	1
5	Suction bypass assembly (includes suction filter)	AL168805AV	1
6	Inlet valve kit	AL168300SJ	1
7	Front cover kit	AL168600SJ	1
8	Outlet valve	AL168341SJ	1
9	Suction filter	AL168820AV	1

# For Replacement Parts and Accessories, Call 1-800-626-4401

Please provide following information:

- Model number
- Serial number (if any)
- Part descriptions and number as shown in parts list

Address parts correspondence to:

Campbell Hausfeld  
Attn: Customer Service  
100 Mundy Memorial Dr.  
Mt. Juliet, TN 37122 U.S.A.

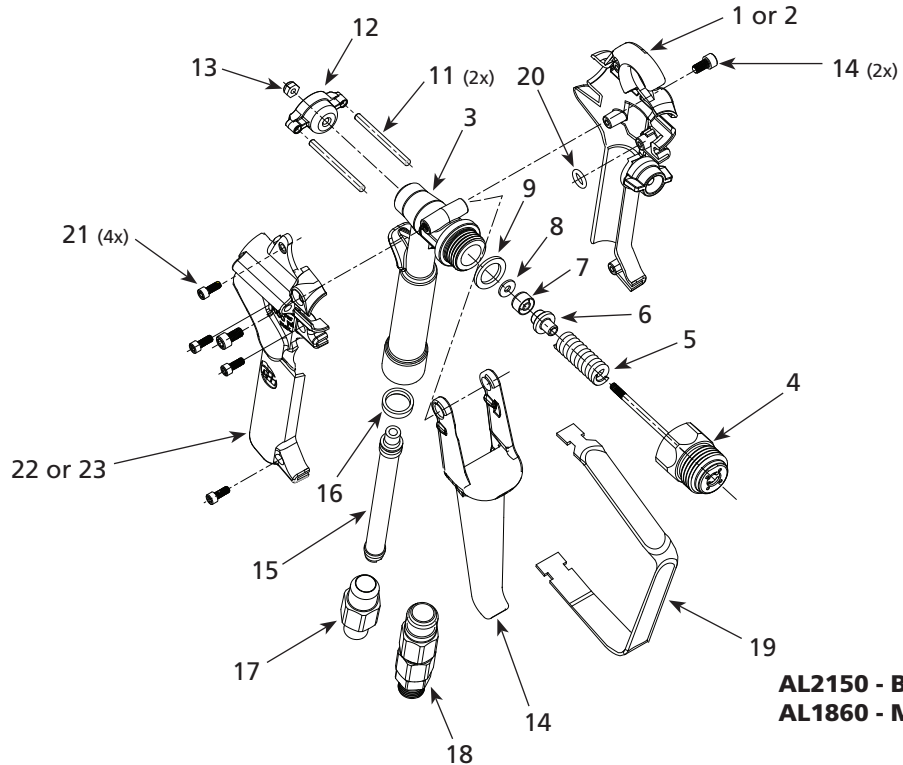
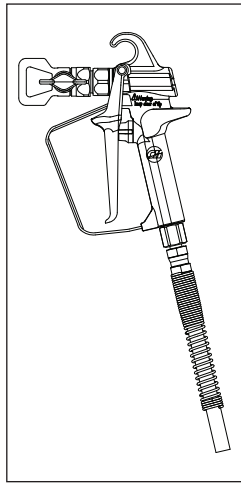

**AL2150 - Black (Std)**  
**AL1860 - Metal (Pro)**

## Replacement Parts List

Ref. No.	Description	Part No.	Qty.	Ref. No.	Description	Part No.	Qty.
1	Kit, Black Gun Left Grip, Lock and Guard	AL184401SV	1	16	Washer, Long Filter	MJ105402AV	1
2	Kit, Pro Gun Left Grip, Lock and Guard	AL184400SV	1	17	Adapter, Long Filter	AL072301AV	1
3	Insert, Gun	AL179803AG	1	18	Assembly, Pro Gun Swivel (optional)	AL183500AJ	1
4	Kit, Pro Stem and Diffuser (includes #7)	AL183400SV	1	19	Guard, Pro Gun Trigger	AL184600AV	1
5	Spring, Gun	AL048600AV	1	20	O-Ring	MJ106511AV	1
6	Retainer, Gun Spring	AL020201AV	1	21	Screw, #5-40 x 5/16" SHC	MJ103804AV	4
7	Seal, Gun	AL020300AV	1	22	Grip, Right, Pro Gun	AL184302AV	1
8	Washer, Seal	AL153801AV	1	23	Grip, Right, Black Gun	AL184301AV	1
9	Washer, Gun Seat Retainer	AL005404AV	1	<b>ADDITIONAL ITEMS AVAILABLE:</b>			
10	Kit, Gun Seal (Includes #7, #8, #9)	AL183600SV	1	Kit, Pro Gun Valve – Includes #4 - #9, #13			AL183200SV
11	Pin, Gun Actuator	AL024102AV	2	Kit, Gun Actuator – Includes #11, #12, #13			AL183700SV
12	Actuator, Gun	AL182700AV	1	Kit, Pro Gun Insert – Includes #3 - #9, #16			AL184100SV
13	Nut, #5-40 Hex Lock	ST073804AV	1	Kit, Pro Gun Full Grip – Includes #2, #19 - #22			AL184500SV
14	Kit, Gun Trigger (Trigger, Screws)	AL183100SV	1				
15	Gun Filters,						
	100 Mesh (yellow)	AL086101AJ	2 pk				
	50 Mesh (white)	AL086100AJ	2 pk				

## Troubleshooting Chart

Symptom	Possible Cause(s)	Corrective Action
Motor hums and does not run	1. Supply voltage too low	1. Do not use an extension cord, it is better to add hose length. Use portable generator with a 2400 VA minimum rating
Motor does not run or hum	2. Power Switch is in OFF position 3. Pressure knob is set to zero. 4. Bad power connection 5. Circuit breaker or fuse is tripped 6. Thermal overload protection activated	2. Flip Power Switch to ON position 3. Turn pressure knob clockwise to increase pressure. 4. Check power connections at power receptacle, along extension cord and at equipment for looseness or damage 5. Correct cause of circuit overload. (Possible causes: Supply voltage too low, extension cord too long for available supply voltage, or motor has been damaged.) 6. Allow motor to cool for approximately 30 minutes, determine cause and restart motor. (Possible causes: Supply voltage too low, extension cord too long for available supply voltage, or motor has been damaged.)
Motor runs, but pump does not prime after being cleaned after last use. (This problem can usually be prevented by following the recommended cleaning and storage procedure)	7. Check valves stuck 8. Suction Assembly loose and/or sealing surfaces are dirty at Inlet Valve 9. Suction Head not immersed in paint 10. Prime/Spray Control is in the SPRAY position	7. "Pop" Inlet Valve and Outlet Valves. Call 1-800-626-4401 8. Remove Suction Assembly, clean sealing surfaces and reassemble 9. Add more paint to bucket and/or adjust position of Suction Assembly 10. Turn the Prime/Spray Control to the Prime position
Motor runs, but pump does not prime even though it was working just fine a little while ago. (Usually occurs after moving or adding more paint to the paint bucket.)	11. See Possible Causes 8, 9, 10 12. Clogged suction filter 13. Trash caught in valves 14. Paint sediments settled to bottom of bucket	11. See Corrective Actions 8, 9, 10 12. Remove suction filter and clean. Also, refer to Maintenance section 13. See "Force Feeding" figure on page 22 14. Strain and mix paint thoroughly
Pump primes, but does not build pressure	15. Prime/Spray Control not in Spray position 16. Pressure Control not set to high enough pressure 17. Even though Prime/Spray Control is in Spray position, fluid still flows from By-Pass Tube. Prime/Spray Control is worn or damaged	15. Turn Prime/Spray Control to Spray position 16. Turn Pressure Control clockwise to desired pressure. Fully clockwise is maximum pressure 17. Call 1-800-626-4401
Pump primes and builds pressure, however, the equipment does not spray or produce a quality spray pattern	18. Clogged gun filter 19. Clogged Spray Tip 20. A. Tip is damaged or worn B. Paint requires thinning C. Reversible Spray Tip in cleaning position	18. Replace with new filter. Do not attempt to clean gun filters. Also, refer to Maintenance section 19. See Clearing Clogs section 20. A. Replace tip. Also, refer to Maintenance section B. Follow paint manufacturers thinning recommendations. Paint should not typically need to be thinned more than 8 oz. of solvent per gallon C. Turn Spray Tip to Spray position. See Cleaning section for details

*Continued on next page*

## Troubleshooting Chart (Continued)

Symptom	Possible Cause(s)	Corrective Action
Pump primes and builds pressure, but does not maintain pressure once trigger is pulled	21. Clogged Suction Filter	21. Remove Suction Filter and clean. Also, refer to Maintenance section
	22. Suction Assembly loose and/or sealing surfaces are dirty at Inlet Valve	22. Remove Suction Assembly, clean sealing surfaces and reassemble
	23. Paint thick due to cold weather. This problem usually occurs with Latex based coatings	23. Do not paint Latex coatings in temperatures less than 50°F (10°C). Refer to paint manufactures minimum painting temperature recommendations
	24. Inlet Valve and/or Outlet Valve are worn	24. Replace valves. Also, refer to Maintenance section
Gun will not shut-off	25. Trash caught in Gun Valve	25. Clean or replace Gun valve. Also, refer to Gun Maintenance section. This is a very rare occurrence, and will not occur if filters are properly maintained
	26. Worn Gun Valve	26. Replace Gun valve. Also, refer to Gun Maintenance section
	27. Dried paint under gun actuator	27. Remove 1/4" nut and gun actuator at rear of gun. Remove dried paint from around needle and back of actuator. Replace actuator and 1/4" nut. Set gun trigger position with trigger lock in locked orientation (tabs horizontal) by the following instructions: With one hand holding trigger softly against lock, use a 1/4" nut driver to turn nut in until trigger starts to come off the lock, then back off the nut (counterclockwise) 1/2 turn. Pulling the trigger must not open the gun valve when trigger lock is activated. You should be able to get the actuator to wiggle slightly with your finger while holding the trigger against the locked trigger lock.
After moving equipment or adding paint to bucket, unit will not prime or spray	28. Suction assembly loose or damaged	28. Tighten suction assembly onto inlet valve. Re-prime sprayer. If problem is not remedied, consult Technical Support
Oil in Paint	29. Pump was not flushed prior to use	29. Flush unit prior to use (See preparation section).
Fluid leaks	30. Loose connection	30. Clean sealing surface and reassemble per assembly instructions
	31. Contaminated sealing surface	31. Consult technical support
	32. Damaged component	32. Consult technical support
Symptoms not listed or unsuccessful in resolving issue	33. Possible product quality issue. (We would greatly appreciate your assistance in continuous product quality improvement)	33. Call technical support at 1-800-626-4401

# Airless Paint Sprayers

## “Force Feeding” Pump

To remove trash that has been caught in the valves, the unit can be force fed. With pump on and prime/spray knob turned to “prime” position, pour the appropriate solvent into the suction tube and then fold hose as shown opposite. While firmly squeezing the suction tube, slide hand down toward the pump and repeat until pump primes.

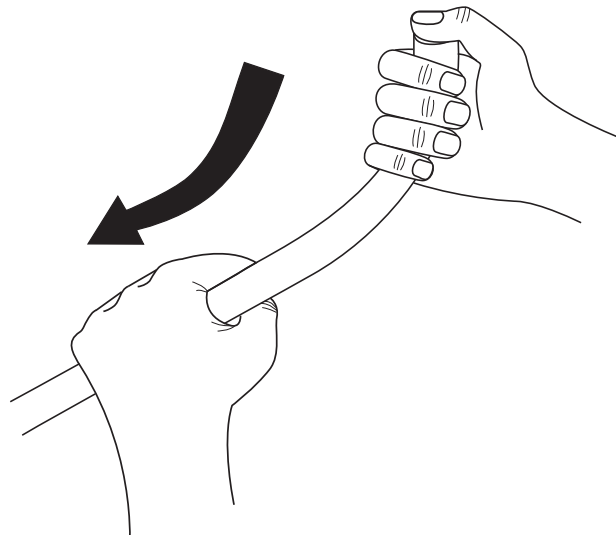
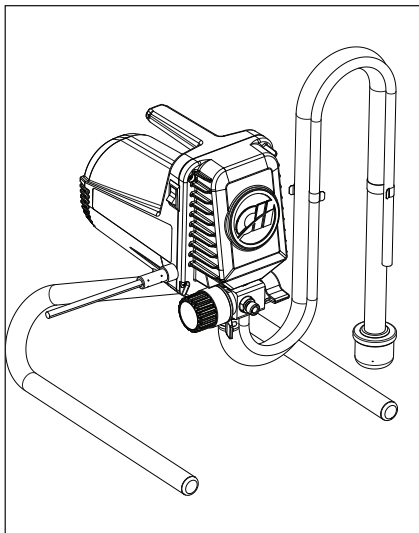
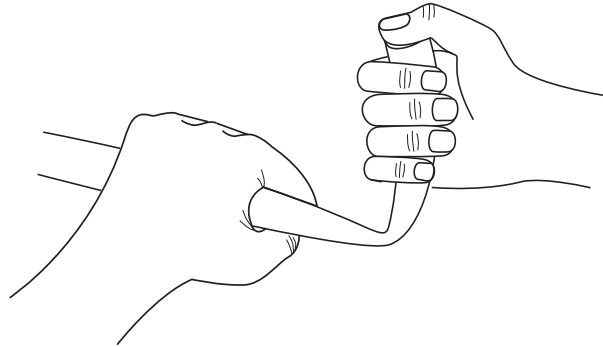

## Notes:

- Weather conditions can cause unsatisfactory results when spraying some coatings.
- High humidity prolongs set, and cure times.
- High temperatures decrease set, and cure times.
- Cold temperatures extend set, and cure times.
- Variations in temperature, and humidity can cause variations in finish quality.
- Coating manufacturers can recommend additives to resolve some of these problems, and should be contacted for assistance with particular problem resolutions.



---

# Airless Paint Sprayers

---

## **Limited Warranty**

1. **DURATION:** From the date of purchase by the original purchaser as follows: Paint Application Systems - 1 year. All Paint Spray Guns and Paint Application Accessories - 1 year.
2. **WHO GIVES THIS WARRANTY (WARRANTOR):** Campbell Hausfeld/A Scott Fetzer Company, 100 Production Drive, Harrison, Ohio, 45030, Telephone: 1-800-626-4401.
3. **WHO RECEIVES THIS WARRANTY (PURCHASER):** The original purchaser (other than for purposes of resale or rental) of the Campbell Hausfeld Product.
4. **WHAT PRODUCTS ARE COVERED BY THIS WARRANTY:** All non-compressor driven paint application systems, HVLP spraying systems, and paint application accessories supplied or manufactured by the Warrantor.
5. **WHAT IS COVERED UNDER THIS WARRANTY:** Defects in material and workmanship which occur within the duration of the warranty period. Warrantor will also cover normal wear items for a period of thirty days from the date of original purchase against defects in material and workmanship. These wear items are: HVLP-filters, motor brushes, gun packing, gun canister seal, gun check valve and gun air flow ring; Airless-inlet valve, outlet valve, gun valve, filters, tips, all seals and o-rings.
6. **WHAT IS NOT COVERED UNDER THIS WARRANTY:**
  - A. Implied warranties, including those of merchantability and FITNESS FOR A PARTICULAR PURPOSE ARE LIMITED FROM THE DATE OF ORIGINAL PURCHASE AS STATED IN THE DURATION. If this product is used for commercial or industrial purposes, the warranty will be void. If product is used for rental purposes, the warranty will be void. Some states do not allow limitation on how long an implied warranty lasts, so the above limitations may not apply to you.
  - B. ANY INCIDENTAL, INDIRECT, OR CONSEQUENTIAL LOSS, DAMAGE , OR EXPENSE THAT MAY RESULT FROM ANY DEFECT, FAILURE, OR MALFUNCTION OF THE CAMPBELL HAUSFELD PRODUCT. Some states do not allow the exclusion or limitation of incidental or consequential damages, so the above limitation or exclusion may not apply to you.
  - C. Any failure that results from an accident, purchaser's abuse, neglect or failure to operate products in accordance with instructions provided in the owner's manual(s) supplied with product. Accident, purchaser's abuse, neglect or failure to operate products in accordance with instructions shall also include the removal or alteration of any safety devices. If such safety devices are removed or altered, this warranty is void.
  - D. Normal adjustments which are explained in the owner's manual(s) provided with the product.
  - E. Items or services that are normally required to maintain the product: HVLP-filters, motor brushes, gun packing, gun canister seal, gun check valve and gun air flow ring; Airless-inlet valve, outlet valve, gun valve, filters, tips, all seals and o-rings., or any other expendable part not specifically listed, will only be covered for thirty days from date of original purchase.
7. **RESPONSIBILITIES OF WARRANTOR UNDER THIS WARRANTY:** Repair or replace, at Warrantor's option, products or components which are defective, have malfunctioned and/or failed to conform within duration of the warranty period.
8. **RESPONSIBILITIES OF PURCHASER UNDER THIS WARRANTY:**
  - A. Provide dated proof of purchase and maintenance records when calling 1-800-626-4401 for further instructions.
  - B. Use reasonable care in the operation and maintenance of the products as described in the owner's manual(s).
9. **WHEN WARRANTOR WILL PERFORM REPAIR OR REPLACEMENT UNDER THIS WARRANTY:** Repair or replacement will be scheduled and serviced according to the normal work flow at the servicing location, and depending on the availability of replacement parts.

This Limited Warranty applies in the U.S. and Canada only and gives you specific legal rights. You may also have other rights which vary from state to state, or country to country.