

## Operating Instructions

Please read and save these instructions. Read carefully before attempting to assemble, install, operate or maintain the product described. Protect yourself and others by observing all safety information. Failure to comply with instructions could result in personal injury and/or property damage! Retain instructions for future reference.



# Airless Paint Sprayers



Thank you for purchasing a Campbell Hausfeld product. If you have any questions about this product, please call:

**1-800-626-4401**

### Table of Contents

Description .....	2
General Safety Information .....	2
Preparation .....	3
Spraying Instructions .....	5
Maintenance .....	6
Troubleshooting .....	9
Warranty .....	12

# Airless Paint Sprayers

## Description

Airless paint sprayers are capable of spraying a wide variety of latex, oil-based, and alkyd paints, as well as stains, preservatives and other non-abrasive finishes.

These sprayers are also powerful and versatile enough to be used with a variety of options (roller attachment, extra lengths of hose, etc.) to make it an even more efficient tool.

NOTE: Guns pictured in illustrations may be different than the one included with your unit.

## Safety Guidelines

This manual contains information that is very important to know and understand. This information is provided for SAFETY and to PREVENT EQUIPMENT PROBLEMS. To help recognize this information, observe the following symbols.

**⚠ DANGER** *Danger indicates an imminently hazardous situation which, if not avoided, WILL result in death or serious injury.*

**⚠ WARNING** *Warning indicates a potentially hazardous situation which, if not avoided, COULD result in death or serious injury.*

**⚠ CAUTION** *Caution indicates a potentially hazardous situation which, if not avoided, MAY result in minor or moderate injury.*

**⚠ NOTICE** *Notice indicates important information, that if not followed, may cause damage to equipment.*

## Unpacking

After unpacking the unit, inspect carefully for any damage that may have occurred during transit. Make sure to tighten fittings, bolts, etc., before putting unit into service.

**⚠ WARNING** *Do not operate unit if damaged during shipping, handling or use. Damage may result in bursting and cause injury or property damage.*

## General Safety Information

1. Read all manuals included with this product carefully. Be thoroughly familiar with the controls and the proper use of the equipment. 
2. Keep visitors away and NEVER allow children or pets in the work area.
3. Do not smoke or eat when spraying paint, insecticides, or other flammable substances.
4. Always work in a clean environment. To avoid injury and damage to the workpiece, do not aim the spray gun at any dust or debris.
5. When spraying and cleaning, always follow the instructions and safety precautions provided by the material manufacturer (Refer to MSDS).

### ⚠ DANGER

#### ELECTRICAL SHOCK HAZARD:

- Follow all local electrical and safety codes, as well as the National Electrical Code (NEC) and in the United States, the Occupational Safety and Health Act (OSHA).
- This product requires a grounded 120V, 15 Amp circuit (See Figure 1).

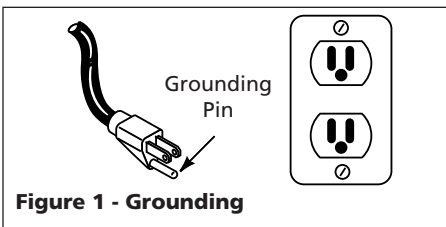



Figure 1 - Grounding

- If the power receptacles available will not fit this equipment's power cord, then have an appropriate power receptacle installed by a certified electrician.
- Only qualified electricians or service personnel should perform maintenance on the electrical components of this equipment.

- Do not modify any of the electrical components of this equipment. 
- Do not use a power cord adapter with this equipment.
- If using an extension cord, use only grounded three wire extension cords that are in good condition.
- Check with a qualified electrician or service person if the grounding instructions are not completely understood or you are in doubt as to whether the equipment is properly grounded.

#### APPROPRIATE EXTENSION CORD GAUGE FOR GIVEN LENGTHS

Length of Cord	Gauge
25'	14
25-50'	12
50-100'	10

### ⚠ WARNING

#### SKIN INJECTION HAZARD:

- High pressure spray can inject toxins into blood stream. If injection occurs, seek emergency medical treatment.

### ⚠ WARNING

*Use a face mask/respirator and protective clothing when spraying. Always spray in a well ventilated area to prevent health and fire hazards. Refer to Material Safety Data Sheets (MSDS) of spray material for details.* 

- Never try to stop leaks with any part of your body.
- This system is capable of producing 3000 psi. Use only Campbell Hausfeld replacement parts rated at 3000 psi or higher.
- Never spray without tip guard.
- Ensure trigger lock is functioning properly. See maintenance section for inspection procedures.

# Airless Paint Sprayers

- Always engage trigger lock when not spraying.
- Do not remove spray tip while cleaning pump.
- Never leave equipment pressurized while unattended.
- Do not clean spray tip while it is attached to the spray gun. Remove spray tip from gun to clean tip guard.
- Ensure tightness of high pressure connections.
- Do not use pliers to tighten or loosen high pressure connections.
- Motor is equipped with an automatic thermal overload. Motor will restart without warning, after cooling.

**▲WARNING** *Never aim or spray at yourself or anyone else or serious injury could occur.*

**Before servicing or resting:**

1. Turn the Prime/Spray Control to the Prime position.
  2. Turn the Pressure Control to Low Pressure/Hydraulic Bleeding position.
  3. Turn Power Switch to OFF position.
  4. With gun pointed in a safe direction, pull the Gun Trigger, with the Trigger Lock disengaged.
  5. Engage Trigger Lock.
- Simply turning off the pump motor will not relieve pressure from system. The above procedure must be followed.

**▲WARNING**

**FIRE OR EXPLOSION HAZARD:**

- Do not use solvents with flash points less than 70° F (21° C) to clean this equipment (examples of acceptable cleaning solvents are water, mineral spirits, lacquer thinner, Xylene and high flash napha. A partial example list of unacceptable

cleaning solvents are low flash napha, mek, acetone, alcohol and toluene).

**▲WARNING**

*Do not spray flammable materials in vicinity of open flame or near ignition sources. Motors, electrical equipment and controls can cause electrical arcs that will ignite a flammable gas or vapor. Never store flammable liquids or gases in the vicinity of the unit.*



**▲WARNING**

*Do not spray acids, corrosive materials, toxic chemicals, fertilizers or pesticides. Using these materials could result in death or serious injury.*

- Do not use fuels to clean this equipment.
- Keep spraying area well ventilated. Keep doors and windows open.
- Remove all ignition sources. (i.e. Static electricity, pilot lights, cigarettes and electrical arcing).
- Airless spraying can cause static electricity. Always ground the pump and spraying surface. Always use a 3-wire grounded extension cord and power receptacle.
- Do not use solvents containing halogenated hydrocarbons.

**▲CAUTION**

*Keep hose away from sharp objects. Bursting hoses may cause injury. Examine hoses regularly and replace if damaged.*

- Check hoses for weak or worn condition before each use, making certain that all connections are secure.

**FAILURE TO FOLLOW THESE INSTRUCTIONS CAN RESULT IN SERIOUS INJURY INCLUDING DEATH.**

**Preparation**

Airless painting systems, unlike most other power tools, require additional care to ensure proper working order. Following these instructions will significantly increase the likelihood of having a positive paint experience. **It is important that the painting equipment is flush/tested EACH time a new job is started.** Each pump is tested at the factory with a fluid that must be flushed from the system prior to painting. It is also required prior to each successive use to flush the storage lubricant from the system. Use the solvent which will be used to clean the equipment. Refer to the paint manufacturer's recommendations for cleaning fluids.

**DO NOT ATTACH THE SUCTION ASSEMBLY UNTIL TOLD TO DO SO IN STEP 6.**

1. Turn Pressure Control fully counter-clockwise to the Low Pressure/Hydraulic Bleeding position (See Figure 2).

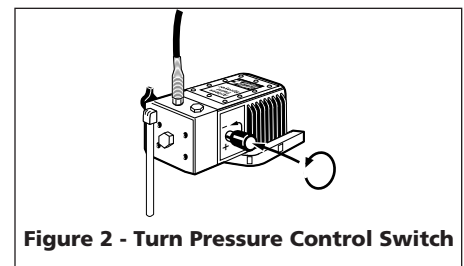

**Figure 2 - Turn Pressure Control Switch**

2. Turn Power Switch to the ON position (See Figure 3).

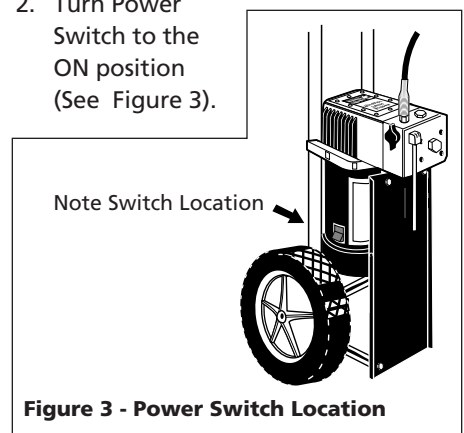
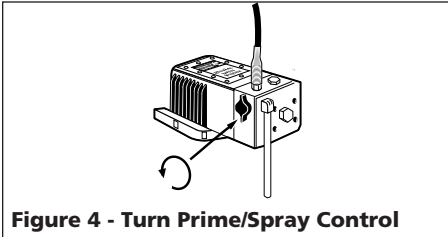

**Figure 3 - Power Switch Location**

# Airless Paint Sprayers

## Preparation (Continued)

3. Turn Prime/Spray Control to the Prime position (See Figure 4).



**Figure 4 - Turn Prime/Spray Control**

4. Push Outlet Push Button three times to ensure Outlet Valve is moving freely (See Figure 5).

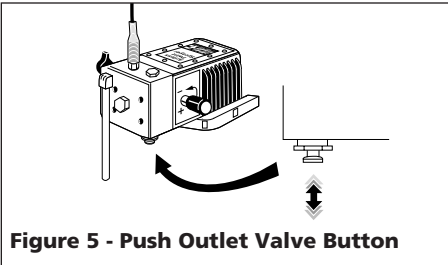

**Figure 5 - Push Outlet Valve Button**

5. Remove Inlet Valve Cap and with your smallest finger, push on Inlet Valve Stem to ensure it moves freely (See Figure 6).

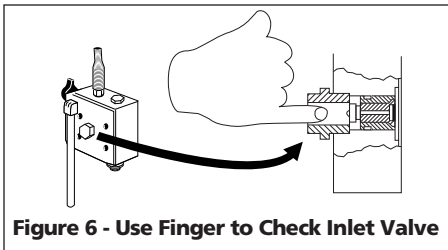

**Figure 6 - Use Finger to Check Inlet Valve**

6. Attach Suction Assembly securely (See Figure 7) and place both suction and bypass tubes in cleaning solvent.

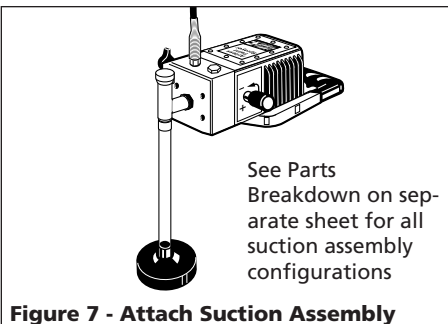

**Figure 7 - Attach Suction Assembly**

7. Turn Pressure Control fully clockwise to High Pressure position. In a few seconds, cleaning solvent will begin to move up through the tube (See Figure 8).

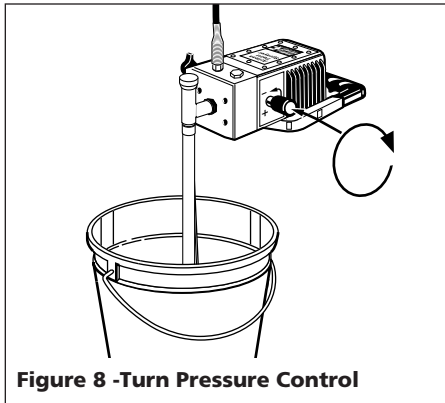

**Figure 8 - Turn Pressure Control**

8. Allow the fluid to circulate for one minute to ensure all air has been exhausted from the pump.
9. Turn Prime/Spray Control to Spray position (See Figure 9). Watch for any fluid leaks. See troubleshooting chart if leaks occur.

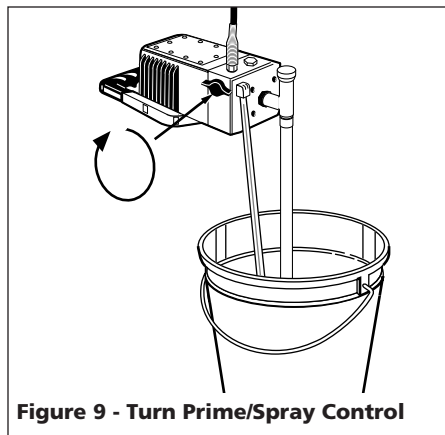

**Figure 9 - Turn Prime/Spray Control**

**NOTE: If unit is building pressure properly, the pump should produce a knocking sound, which indicates it has reached its hydraulic relief pressure.**

10. Rotate Spray Tip to the Cleaning Position (See Figure 10).
11. Release Trigger Lock by pushing and twisting the wings of lock



**Figure 10 - Tip in Cleaning Position**

toward the trigger and rotate so that the lock rests vertically (See Figure 11).

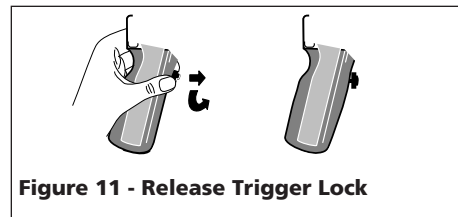
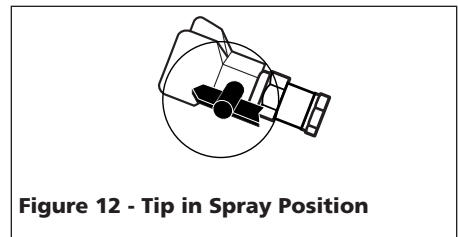

**Figure 11 - Release Trigger Lock**

12. Point Spray Gun into an empty waste bucket and pull Trigger. To reduce splashing, direct the fluid stream along the inside of the bucket wall and well above the fluid level.

13. After completing the flush/testing process, read the section on Spraying Instructions. There are several suggestions on how to obtain professional results.

14. After reading the section on Spraying Instructions, repeat the preceding steps 1 through 11 using paint instead of cleaning solvent. **NOTE:** Strain and thin the paint before using. All paint may have particles that will clog filter and spray tips. Remove any skin which may have developed on the paint due to air exposure. Follow paint manufacturers' recommendations on thinning paint. When performing step 11, continue to spray into the waste bucket until pure paint appears.



**Figure 12 - Tip in Spray Position**

# Airless Paint Sprayers

15. When pure paint appears from Spray Tip rotate tip to the Spray position. The system is now ready for use (See Figure 12).

## Spraying Instructions

Professional looking results can be obtained by following the spray tips below.

1. Keep the gun perpendicular to the surface.

Always hold the gun perpendicular to the surface with the tip approximately 12" from the surface. If held at an angle (up and down or side to side), paint will build up unevenly, leave the work splotchy, and cause excessive overspray (See Figure 13).

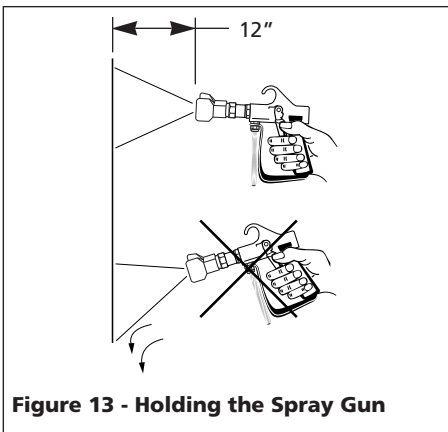

Figure 13 - Holding the Spray Gun

2. Move with a smooth arm stroke  
Move the gun at a steady, even pace while keeping the gun perpendicular to the surface (See Figures 13 & 14). Do not fan the gun. Fanning the gun will cause excessive overspray and uneven coverage (See Figure 14).
3. Start moving the gun before triggering  
To get a smooth overlap and prevent initial paint buildup, start your stroke movement before pulling the trigger. Release the trigger before stopping at the end of the stroke (See Figure 15).

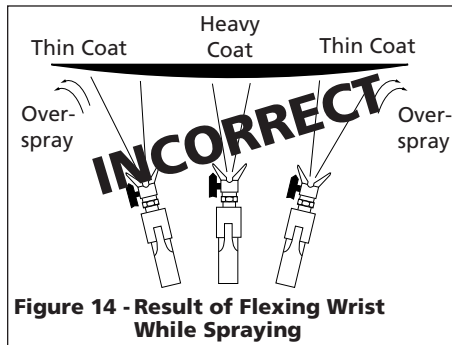

Figure 14 - Result of Flexing Wrist While Spraying

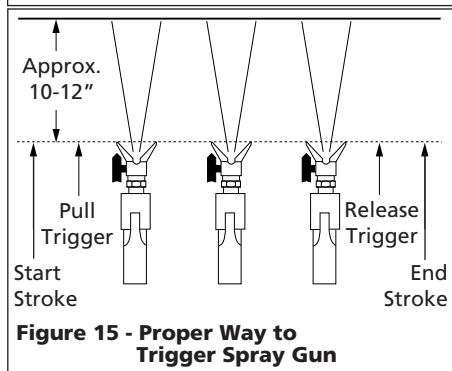

Figure 15 - Proper Way to Trigger Spray Gun

**NOTE:** To assure uniform paint coverage, overlap each stroke by 20% - 30% and use two coats with a cross pattern (one coat horizontal, second coat vertical).

## INTERMITTENT USE

If you are spraying and decide to stop for several minutes, lock the spray gun trigger and submerge the tip in a container of suitable solvent (See Figure 16). This will prevent paint from hardening in the tiny spray opening and clogging the tip. **Be sure to release the pressure by turning the bypass knob to prime and switching off the pump.**

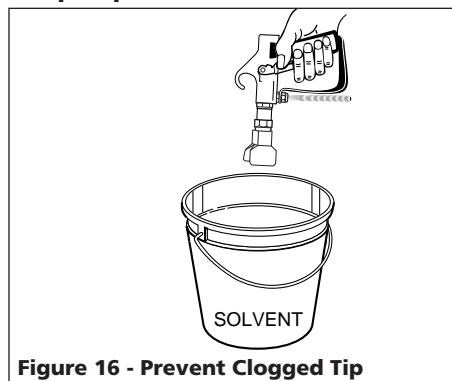

Figure 16 - Prevent Clogged Tip

## CLEARING CLOGS

### REVERSIBLE TIP:

1. Rotate the tip to the clean position (See Figure 25).
2. Point gun in a safe direction and spray. This should clear the tip of any blockage.
3. Rotate the tip back to the spray position and continue spraying (See Fig. 17).



Figure 17 - Clean and Spray Position

4. If the clogging continues, clean or replace the gun filter and see the Preparation section of this manual for instruction on straining and thinning paint.

### ▲ NOTICE

*Equipment damage can occur if a needle or sharp object is used to clean the tip. Tungsten carbide is brittle and can be chipped.*

### FIXED TIP:

1. Turn off the motor and trigger the gun to relieve the pressure in unit.
2. Lock gun trigger.
3. Remove tip and tip guard from the gun.
4. Soak tip in water or appropriate solvent and brush away old paint or impurities with a toothbrush until the tip orifice has been cleared.

### ADJUSTABLE TIP:

1. Turn adjustment knob fully counter-clockwise to open tip to largest spray pattern.
2. Pull trigger and spray into a bucket or container. This should clear the tip of any blockage.
3. If the clogging continues, clean or replace the gun filter and see the "Preparation" section of this manual for instructions on straining and thinning paint.

# Airless Paint Sprayers

## Maintenance

**▲ NOTICE** *Pump damage may occur if these instructions are not followed.*

- Do not use oil based solvents to clean equipment after using latex based coatings. Use only warm soapy water.
- Always replace clogged gun filters, do not attempt to clean them.
- Follow cleaning and storage instructions carefully.
- Do not use metal or other hard objects to pick dried paint material from Spray Tip Orifice.

### CLEANING PUMP

1. Turn Prime/Spray Control to prime position (See Figure 18).

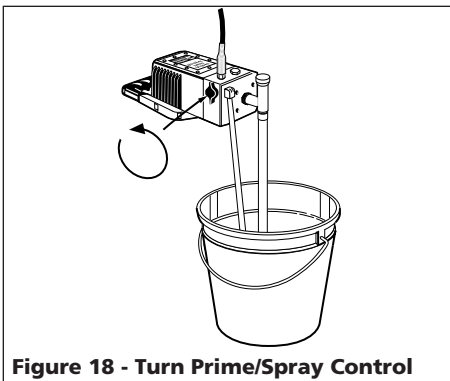

Figure 18 - Turn Prime/Spray Control

2. Turn Pressure Control fully clockwise to high pressure position (See Figure 19).

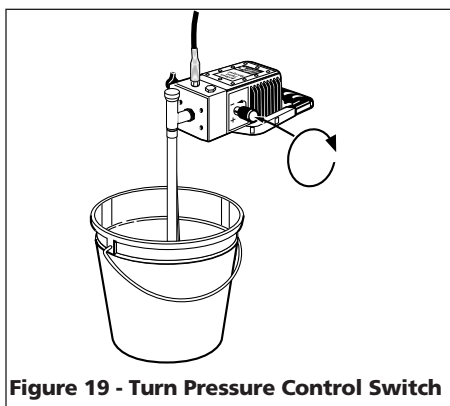

Figure 19 - Turn Pressure Control Switch

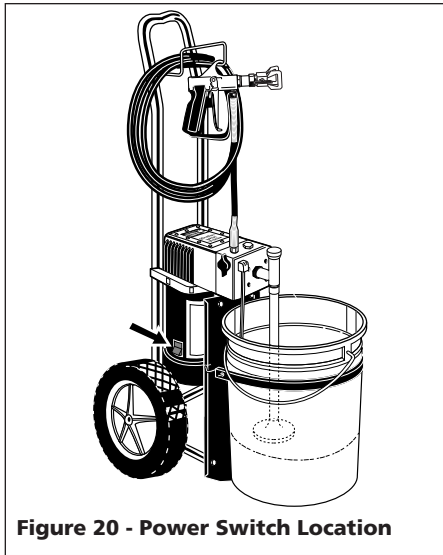

Figure 20 - Power Switch Location

3. Turn Power Switch to ON position (See Figure 20).
4. Lift Suction Assembly above paint level in bucket. Allow pump to run until the majority of paint is exhausted from pump.
5. With the pump still running, immediately place both the Suction Assembly and Bypass Tube into an appropriate solvent. Allow pump to prime and circulate for ten minutes.
6. While fluid is circulating, wipe Suction Assembly and By-Pass Tube with a rag. Also, remove Suction Filter with pliers (See Figure 21).

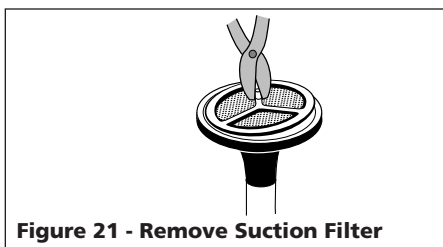

Figure 21 - Remove Suction Filter

Wipe inside of Suction Filter-Housing with a rag. Clean Suction Filter in a separate container of fluid and then reinsert into Suction Filter Housing.

7. Allow the solvent to circulate for an additional minute to ensure all air has been exhausted from the pump.

8. Turn Prime/Spray Control to spray position.
9. Rotate Spray Tip to the cleaning position.
10. Release Trigger Lock.
11. Point Spray Gun into an empty waste bucket and pull the Trigger. Spray at least 1 gallon of fluid into waste bucket. To reduce splashing, direct the fluid stream along the inside of the bucket and well above the fluid level.
12. Repeat steps 1, 5-8, 10 & 11 with fresh solvent.
13. Turn the Prime/Spray Control to the prime position.
14. Turn the Pressure Control fully counterclockwise to Low Pressure/Hydraulic Bleeding position.
15. Turn Power Switch to OFF position.
16. With the gun pointed in a safe direction, pull the Gun Trigger with the Trigger Lock disengaged.
17. Engage Trigger Lock.
18. At this point the pump and spray gun are clean, but still require preparation for storage. Spray Tip Guard or any accessory being used still require cleaning.

### CLEANING SPRAY TIP GUARD:

1. Remove Spray Tip with 13/16" or adjustable wrench.
2. Clean Tip Guard with a cleaning brush.

### Storage

#### SHORT TERM – OVERNIGHT AT SAME JOB SIGHT

If unit was cleaned with mineral spirits, no other preparation for storage is necessary. If the sprayer is going to be reused with the same paint the next day at the same job sight, it is not necessary to flush the paint from the system. (This does not apply to epoxy paints.) This can save significant amounts of time. However it is important to keep air from coming in contact with the paint.

# Airless Paint Sprayers

- Relieve pressure from system.
- Do not disconnect any hoses.
- Place spray gun in a bucket of solvent. Make sure tip of gun is submerged so paint will not dry in spray tip.
- Leave the suction and bypass tubes in the bucket of paint. Make sure that the ends of the suction and by-pass tubes are below the surface of the paint in the bucket. This will keep air from drying the paint inside.
- Pour a very thin layer of solvent over the top of the paint in the paint bucket to keep the paint from drying. (A small amount of solvent can be mixed into the paint the next day without harming the coating.)

## **SHORT TERM – LESS THAN ONE WEEK - WATER BASE PAINT**

Orient pump so that Inlet Valve is facing up. Fill Inlet Valve with Campbell Hausfeld Pump Saver. With Prime/Spray Control in the prime position, turn motor on and allow Pump Saver to be pumped out By-Pass Tube. Reassemble suction assembly. Wrap Suction Filter Housing in plastic to keep debris out of Suction Filter.

## **SHORT TERM - LESS THAN ONE WEEK - OIL BASE PAINT**

If unit was cleaned with mineral spirits, no other preparation for storage is necessary.

## **LONG TERM – MORE THAN ONE WEEK - OIL / WATER BASE PAINT**

1. Orient pump so that Inlet Valve is facing up. Fill Inlet Valve with Campbell Hausfeld Pump Saver. With Prime/Spray Control in the prime position, turn motor on and allow Pump Saver to be pumped out By-Pass Tube. Reassemble suction assembly. Wrap Suction Filter Housing in plastic to keep debris out of Suction Filter.
2. Remove High Pressure Hose and drain. Reassemble High Pressure Hose to pump. With Spray Tip attached to Spray Gun, wrap tip with plastic to protect Spray Tip.

## **Maintenance Notes:**

See chart on next page for maintenance information and then refer to these notes as directed.

1. The Trigger Lock is an extremely important safety feature which helps reduce the risk of accidental injection. The trigger must be adjusted correctly so that when the trigger lock is engaged it is not possible to operate the Spray Gun. This adjustment must be made by a qualified technician.
2. Disconnect fittings only when necessary to prevent damage. Fitting damage can cause unit malfunction or external paint leaks. The most common sealing surface to check is between the Suction Assembly and Inlet Valve.
3. The most critical function of the suction tube assembly is to provide a conduit for the paint from the bucket to the unit. Damaged suction tubes cause air leaks and should be replaced.
4. The suction tube assembly and the bypass tube assembly need to be

replaced periodically if paint build up has occurred. This is to minimize the possibility of dried paint chips from flaking off and getting into the pump.

5. The quality of the paint has a significant impact on the length of time a filter can be used. Some low grade paints can clog filters after using just 1 1/2 gallons. Clogged filters can cause both poor performance and excessive tip clogging.
6. Function of the Inlet Valve, Outlet Valve, Diaphragm assembly, pressure valve and the oil are not readily observable. Replacement as specified in Maintenance Chart will significantly increase sprayer performance.
7. The Spray Tip is the most critical component in achieving a quality paint job. Therefore, it is important to pay close attention to how the Spray Tip is performing during the paint job.

See Helpful Hints section for details about information concerning Spray Tip performance. Ensure that it is free of paint. Do not use sharp objects to clean any sealing surface.

8. This pump should not lose oil. If it has, then there are four possible leakage points:
  - 1) Face plate gasket
  - 2) Motor shaft seal
  - 3) Between block and housing
  - 4) Through diaphragm

Some of these leakages may be severe enough to require service center attention. Oil level should be 1/4" from top edge of hydraulic housing.

9. If block is removed for any reason, diaphragm must also be replaced.
10. Follow torquing instructions that come with service kit.

# Airless Paint Sprayers

## Maintenance Chart

See previous page for maintenance notes

Maintenance Item	Check	Replace	User Serviceable?	Detail Notes
Product safety labels	Before each use	As required	Yes	See parts listing for location of product safety labels and related part numbers.
Trigger adjustment	Before each use, See note one		No	
Airless hose	Before each use		Yes	Read information on the hang tag attached to the high pressure hose for instructions on maintenance.
Sealing surfaces	Before each use		Yes	See note 2
Suction tube	Before each use	See notes 3 & 4	Yes	
By-Pass tube	Before each use	See note 4	Yes	
Suction filter	Before each use and every 5 gal. See note 5	Every 25 gal. or more often if required	Yes	
Gun filter	Before each use	Every 25 gal.	Yes	Do not attempt to clean gun filter, only replace.
Roller nap	Before each use	As required	Yes	
Prime/Spray valve	Before each use	Every 1000 gal.	Yes	3/4" Wrench, torque to 80 in/lbs.
Push-Pull	Before each use	Every 1000 gal.	Yes	5/8" Socket or wrench, torque to 150 in/lbs.
Block bolts	Before each use	Do not require replacement with normal use	Yes	Block bolts are to be torqued to 275 in/lbs. in an "X" pattern. These bolts should be checked periodically for correct torque.
Pressure valve	See note 6	Does not require repl. with normal use	*SCR	1 1/16" Socket, torque to 150 in/lbs.
Inlet valve	See note 6	Every 250 gal.	Yes	3/4" Wrench, torque to 150 in/lbs.
Outlet valve	See note 6	Every 250 gal.	Yes	See note 7
Spray tip	Before each use	Every 20-75 gal.	Yes	13/16" Wrench torque to 135 in/lbs.
Diaphragm assembly	See note 6	Every 1000 gal.	*SCR	See notes 9 and 10
Oil	See note 6	Every 2000 gal.	Yes	See note 8
Block	See note 9	Does not require replacement with normal use	Yes	See notes 9 and 10



# Airless Paint Sprayers

## Troubleshooting Chart

Symptom	Possible Cause(s)	Corrective Action
Motor hums and does not run	<ol style="list-style-type: none"> <li>1. Unit under pressure</li> <li>2. Equipment has been dropped which caused motor to become misaligned</li> <li>3. Supply voltage too low</li> </ol>	<ol style="list-style-type: none"> <li>1. Turn Prime/Spray Control to prime position</li> <li>2. Take to authorized service center to have motor assembly realigned. Or, call technical support</li> <li>3. Do not use an extension cord, it is better to add hose length. Use portable generator with a 2400 VA minimum rating</li> </ol>
Motor does not run or hum	<ol style="list-style-type: none"> <li>4. Power Switch is in OFF position</li> <li>5. Bad power connection</li> <li>6. Circuit breaker or fuse is tripped</li> <li>7. Thermal overload protection activated</li> </ol>	<ol style="list-style-type: none"> <li>4. Flip Power Switch to ON position</li> <li>5. Check power connections at power receptacle, along extension cord and at equipment for looseness or damage</li> <li>6. Correct cause of circuit overload. (Possible causes: Supply voltage too low, extension cord too long for available supply voltage, equipment was under pressure while trying to start motor or motor has been damaged due to dropage)</li> <li>7. Allow motor to cool for approximately 30 minutes, determine cause and restart motor. (Possible causes: Supply voltage too low, extension cord too long for available supply voltage, equipment was under pressure while trying to start motor or motor has been damaged due to dropage)</li> </ol>
<p>Motor runs, but pump does not prime after being cleaned after last use</p> <p>(This problem can usually be prevented by following the recommended cleaning and storage procedure on pages 6 &amp; 7)</p>	<ol style="list-style-type: none"> <li>8. Check valves stuck</li> <li>9. Suction Assembly loose and/or sealing surfaces are dirty at Inlet Valve</li> <li>10. Suction Head not immersed in paint</li> <li>11. Prime/Spray Control is in the spray position and/or the Pressure Control is in the Low Pressure/Hydraulic Bleeding position</li> <li>12. Hydraulic system contains air</li> <li>13. Hydraulic oil level low</li> </ol>	<ol style="list-style-type: none"> <li>8. "Pop" Inlet Valve and Outlet Valves. See step 5 of Preparation instructions</li> <li>9. Remove Suction Assembly, clean sealing surfaces and reassemble</li> <li>10. Add more paint to bucket and/or adjust position of Suction Assembly</li> <li>11. Turn the Prime/Spray Control to the Prime position and Pressure Control fully clockwise</li> <li>12. Turn Pressure Control to Low Pressure/Hydraulic Bleeding position for 1 minute while motor is running</li> <li>13. Add oil so level is within 1/4" of housing edge. (See notes in Maintenance Section on oil leaks.) Turn Pressure Control to Low Pressure/Hydraulic Bleeding position for 1 minute</li> </ol>

# Airless Paint Sprayers

## Troubleshooting Chart (Continued)

Symptom	Possible Cause(s)	Corrective Action
Motor runs, but pump does not prime even though it was working just fine a little while ago  (Usually occurs after moving or adding more paint to the paint bucket.)	14. See Possible Causes 9,10,11,13	14. See Corrective Actions 9,10,11,13
	15. Clogged suction filter	15. Remove suction filter with pliers and clean. Also, refer to Maintenance section
	16. Trash caught in valves	16. See figure 22 at the end of this section
	17. Paint sediments settled to bottom of bucket	17. Strain and mix paint thoroughly
Pump primes, but does not build pressure	18. Prime/Spray Control not in Spray position	18. Turn Prime/Spray Control to Spray position
	19. Pressure Control not set to high enough pressure	19. Turn Pressure Control clockwise to desired pressure. Fully clockwise is maximum pressure
	20. Even though Prime/Spray Control is in Spray position, fluid still flows from By-Pass Tube. Prime/Spray Control is worn or damaged	20. Replace with service kit (See replacement parts list) or take equipment to authorized service center
Pump primes and builds pressure, however, the equipment does not spray or produce a quality spray pattern	21. Clogged gun filter	21. Replace with new filter. Do not attempt to clean gun filters. Also, refer to Maintenance section
	22. Clogged Spray Tip	22. See Clearing Clogs section
	23 a. Tip is damaged or worn b. Paint requires thinning c. Reversible Spray Tip in cleaning position	23 a. Replace tip. Also, refer to Maintenance section. b. Follow paint manufacturers thinning recommendations. Paint should not typically need to be thinned more than 8 oz. of solvent per gallon c. Turn Spray Tip to Spray position. See Cleaning section for details
Pump primes and builds pressure, but does not maintain pressure once trigger is pulled	24. Clogged Suction Filter	24. Remove Suction Filter with pliers and clean. Also, refer to Maintenance section
	25. Suction Assembly loose and/or sealing surfaces are dirty at Inlet Valve	25. Remove Suction Assembly, clean sealing surfaces and reassemble hand tight
	26. Paint thick due to cold weather. This problem usually occurs with Latex based coatings	26. Do not paint Latex coatings in temperatures less than 50° F (10° C). Refer to paint manufactures minimum painting temperature recommendations
	27. Inlet Valve and/or Outlet Valve are worn	27. Replace valves. Also, refer to Maintenance section
Gun will not shut-off	28. Trash caught in Gun Valve	28. Replace Gun Insert. Also, refer to Maintenance section. This is a very rare occurrence, and will not occur if filters are properly maintained
	29. Worn Gun Valve	29. Replace Gun Insert. Also, refer to Maintenance section

# Airless Paint Sprayers

## Troubleshooting Chart (Continued)

Symptom	Possible Cause(s)	Corrective Action
After moving equipment or adding paint to bucket, unit will not prime or spray	Pump has lost prime	Refer to steps 3-9 in the Preparation section
Oil in Paint	30. Oil is leaking from between Block and Hydraulic Housing 31. Diaphragm is damaged	30. Tighten Block Bolts. If problem is not remedied, Diaphragm needs to be replaced 31. Replace. It is recommended that this be done by a qualified technician
Fluid leaks other than oil	32. Loose connection 33. Contaminated sealing surface 34. Damaged component	32. Refer to assembly instructions concerning appropriate size and type of tools required and torque requirements 33. Clean sealing surface and reassemble per assembly instructions 34. Consult technical support
Symptoms not listed	Possible product quality issue. (We would greatly appreciate your assistance in continuous product quality improvement)	Call technical support at 1-800-626-4401

To remove trash that has been caught in the valves, the unit can be force fed. With pump on and prime/spray knob turned to "prime" position, pour the appropriate solvent into the suction tube and then fold hose as shown below. While firmly squeezing the suction tube, slide hand down toward the pump and repeat until pump primes. (See Figure 22).

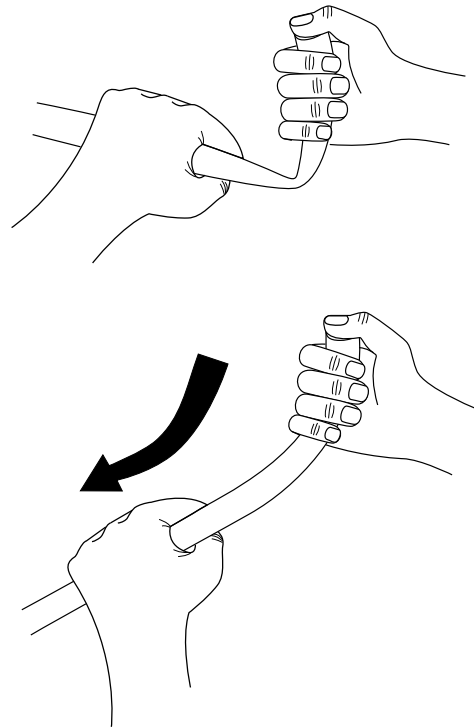

Figure 22 - "Force Feeding" the pump

# Airless Paint Sprayers

---

## Notes:

- Weather conditions can cause unsatisfactory results when spraying some coatings.
  - High humidity prolongs set, and cure times.
  - High temperatures decrease set, and cure times.
  - Cold temperatures extend set, and cure times.
  - Variations in temperature, and humidity can cause variations in finish quality.
  - Coating manufacturers can recommend additives to resolve some of these problems, and should be contacted for assistance with particular problem resolutions.
- 

## Limited Warranty

1. DURATION: 1 year from the date of purchase by the original purchaser, for defects in material or workmanship.
2. WHO GIVES THIS WARRANTY (WARRANTOR): The Campbell Group  
Division / Scott Fetzer Co.  
100 Production Drive  
Harrison, Ohio 45030
3. WHO RECEIVES THIS WARRANTY (PURCHASER): The original purchaser (other than for purposes of resale or rental) of the Campbell Hausfeld product.
4. WHAT PRODUCTS ARE COVERED UNDER THIS WARRANTY: Any Campbell Hausfeld Airless Paint Sprayer or accessory supplied or manufactured by the Warrantor.
5. WHAT IS COVERED UNDER THIS WARRANTY: Defects in material and workmanship which occur within the duration of the warranty period.
6. WHAT IS NOT COVERED UNDER THIS WARRANTY:
  - A. IMPLIED WARRANTIES, INCLUDING THOSE OF MERCHANTABILITY AND FITNESS FOR A PARTICULAR PURPOSE, ARE LIMITED TO ONE YEAR FROM THE DATE OF ORIGINAL PURCHASE. Some states do not allow the exclusion or limitation of incidental or consequential damages, so the above limitation or exclusion may not apply to you.
  - B. ANY INCIDENTAL, INDIRECT, OR CONSEQUENTIAL LOSS, DAMAGE OR EXPENSE THAT MAY RESULT FROM ANY DEFECT, FAILURE, OR MALFUNCTION OF THE CAMPBELL HAUSFELD PRODUCT. Some states do not allow the exclusion or limitation if incidental or consequential damages, so the above limitation may not apply to you.
  - C. Any failure that results from an accident, purchaser's abuse, neglect or failure to operate the products in accordance with the instruction provided in the owner's manual(s) provided with the product.
  - D. Pre-delivery service, i.e., assembly, oil, or lubricants and adjustments.
  - E. Normal adjustments which are explained in the owner's manual provided with the product.
  - F. Items or service that are normally required to maintain the product i.e., lubricants, filters, and gaskets.
  - G. Electric motor and gasoline engine components are expressly excluded from coverage under this limited warranty. Such components should be returned by the purchaser to the original manufacturer or to its authorized repair stations for service.
  - H. Damage to the product from use with chemicals not compatible with aluminum or high pressure spraying, e.g. halogenated hydrocarbons, sodium hypochlorite, etc.
7. RESPONSIBILITIES OF WARRANTOR UNDER THIS WARRANTY: Repair or replace, at Warrantor's option, products or components which have failed within the duration of the warranty period.
8. RESPONSIBILITIES OF PURCHASER UNDER THIS WARRANTY:
  - A. Deliver or ship the Campbell Hausfeld product to the nearest Campbell Hausfeld Authorized Service Center. Freight costs, if any, must be borne by the purchaser.
  - B. Use reasonable care in the operation and maintenance of the product as described in the owner's manual.
9. WHEN WARRANTOR WILL PERFORM REPAIR OR REPLACEMENT UNDER THIS WARRANTY:
  - A. Repair or replacement will be scheduled and according to the normal work flow at the servicing location, and depending on the availability of replacement parts.
  - B. If the purchaser does not receive satisfactory results from an Authorized Service Center, the purchaser should contact the Campbell Hausfeld Customer Service Department (see paragraph 2).

This warranty gives you specific legal rights, and you may also have other rights which vary from state to state.

---