

Limited Warranty

1. **DURATION:** From the date of purchase by the original purchaser as follows: Campbell Hausfeld (Standard Duty and Unannounced) – One (1) Year, (Serious Duty) – Two (2) Years, (Extreme Duty) – Three (3) Years; IronForce by Campbell Hausfeld – One (1) Year; Farmhand – Three (3) Years; Maxus – Five (5) Years.
 2. **WHO GIVES THIS WARRANTY (WARRANTOR):** Campbell Hausfeld / Scott Fetzer Company, 100 Production Drive, Harrison, Ohio, 45030, Telephone: (800) 543-6400
 3. **WHO RECEIVES THIS WARRANTY (PURCHASER):** The original purchaser (other than for purposes of resale) of the Campbell Hausfeld product.
 4. **WHAT PRODUCTS ARE COVERED BY THIS WARRANTY:** Any Campbell Hausfeld nailer, stapler, air tool, spray gun, inflator or air accessory supplied or manufactured by Warrantor.
 5. **WHAT IS COVERED UNDER THIS WARRANTY:** Substantial defects in material and workmanship which occur within the duration of the warranty period.
 6. **WHAT IS NOT COVERED UNDER THIS WARRANTY:**
 - A. Implied warranties, including those of merchantability and FITNESS FOR A PARTICULAR PURPOSE ARE LIMITED FROM THE DATE OF ORIGINAL PURCHASE AS STATED IN THE DURATION. If this product is used for commercial, industrial or rental purposes, the warranty will apply for ninety (90) days from the date of purchase. Some States do not allow limitation on how long an implied warranty lasts, so the above limitations may not apply to you.
 - B. ANY INCIDENTAL, INDIRECT, OR CONSEQUENTIAL LOSS, DAMAGE, OR EXPENSE THAT MAY RESULT FROM ANY DEFECT, FAILURE, OR MALFUNCTION OF THE CAMPBELL HAUSFELD PRODUCT. Some States do not allow the exclusion or limitation of incidental or consequential damages, so the above limitation or exclusion may not apply to you.
 - C. Any failure that results from an accident, purchaser's abuse, neglect or failure to operate products in accordance with instructions provided in the owner's manual(s) supplied with product. Accident, purchaser's abuse, neglect or failure to operate products in accordance with instructions shall also include the removal or alteration of any safety devices. If such safety devices are removed or altered, this warranty is void.
 - D. Normal adjustments which are explained in the owner's manual(s) provided with the product.
 - E. Items or service that are normally required to maintain the product, i.e. o-rings, springs, bumpers, debris shields, driver blades, fuses, batteries, gaskets, packings or seals, fluid nozzles, needles, sandblast nozzles, lubricants, material hoses, filter elements, motor vanes, abrasives, blades, cut-off wheels, chisels, chisel retainers, cutters, collets, chucks, rivet jaws, screw driver bits, sanding pads, back-up pads, impact mechanism, or any other expendable part not specifically listed. These items will only be covered for ninety (90) days from date of original purchase. Underlined items are warranted for defects in material and workmanship only.
 - F. Cosmetic defects that do not interfere with the product's function.
 7. **RESPONSIBILITIES OF WARRANTOR UNDER THIS WARRANTY:** Repair or replace, at Warrantor's option, products or components which are defective, have malfunctioned and/or failed to conform within duration of the warranty period.
 8. **RESPONSIBILITIES OF PURCHASER UNDER THIS WARRANTY:**
 - A. Provide dated proof of purchase and maintenance records.
 - B. Deliver or ship the Campbell Hausfeld product or component to the nearest Campbell Hausfeld Authorized Service Center. Freight costs, if any, must be borne by the purchaser.
 - C. Use reasonable care in the operation and maintenance of the products as described in the owner's manual(s).
 9. **WHEN WARRANTOR WILL PERFORM REPAIR OR REPLACEMENT UNDER THIS WARRANTY:** Repair or replacement will be scheduled and serviced according to the normal work flow at the servicing location, and depending on the availability of replacement parts.
- This Limited Warranty applies in the United States, Canada and Mexico only and gives you specific legal rights. You may also have other rights which vary from state to state or country to country.

See Warranty on page 8 for important information about commercial use of this product.

Please read and save these instructions. Read carefully before attempting to assemble, install, operate or maintain the product described. Protect yourself and others by observing all safety information. Failure to comply with instructions could result in personal injury, death and/or property damage! Retain instructions for future reference.

MAXUS 1 1/4" Brad Nailer

Table of Contents

General Safety1-3
 Specifications2
 Operating The Nailer3-5
 Operational Mode4
 Troubleshooting7
 Warranty8

Description

This nailer is designed for decorative trim, molding, window casings, furniture trim and picture frame assembly. Features include: no-mar tip, adjustable exhaust, single sequential trigger, quick clear nose, and an adjustable depth of drive mechanism.

General Safety Information

CALIFORNIA PROPOSITION 65

ADANGER You can create dust when you cut, sand, drill or grind materials such as wood, paint, metal, concrete, cement, or other masonry. This dust often contains chemicals known to cause cancer, birth defects, or other reproductive harm. Wear protective gear.



This manual contains safety, operational and maintenance information. Contact your Campbell Hausfeld representative if you have any questions.

OPERATOR'S RESPONSIBILITY:

- The tool operator is responsible for:
 - Reading and understanding tool labels and manual.
 - Selecting an appropriate tool actuation system, taking into consideration the work application for which the tool is used.
 - The safe use of the tool.
 - Ensuring that the tool is used only when the operator and all other personnel in the work area are wearing ANSI Z87 eye protection equipment, and when required, other appropriate protection equipment such as head, hearing and foot protection equipment. Serious eye or permanent hearing loss could result.
 - Assuring that the tool is kept in safe working order as described in this manual.



EMPLOYER'S RESPONSIBILITY:

- Selecting an appropriate tool actuation system, taking into consideration the work application for which the tool is used.
- Ensuring that this manual is available to operators and personnel performing maintenance.
- The safe use of the tool.
- Enforcing that the tool is used only when the operator and all other personnel in the work area are wearing ANSI Z87 eye protection equipment, and when required, other appropriate protection equipment such as head, hearing and foot protection equipment. Serious eye or permanent hearing loss could result.



Model MXN10100

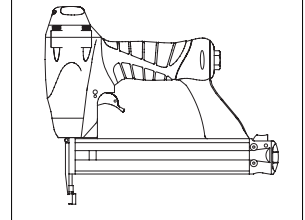

Locate model and vendor date code on tool magazine and nozzle shield, and record below:

Model No. _____
 Date Code. _____
 Retain these numbers for future reference.

tion equipment such as head, hearing and foot protection equipment. Serious eye or permanent hearing loss could result.

- Assuring that the tool is kept in safe working order as described in this manual.
- Assuring the proper maintenance of all tools in employer's possession.
- Ensuring that tools which require repair are not further used before repair. Tags and physical segregation are recommended means of control.

REMINDER: Keep your dated proof of purchase for warranty purposes! Attach it to this manual or file it for safekeeping.

Campbell Hausfeld Nailers meet or exceed Industries' Standards as set forth by the American National Standard Institute/International Staple, Nail and Tool Association in ANSI/ISANTA SNT-101-2002.
 © 2004 Campbell Hausfeld/Scott Fetzer

General Safety Information (Continued)

⚠ DANGER Danger indicates an imminently hazardous situation which, if not avoided, WILL result in death or serious injury.

- Read and understand tool labels and manual. Failure to follow warnings, dangers, and cautions could result in DEATH or SERIOUS INJURY.



- Do not use any type of reactive gases, including, but not limited to, oxygen and combustible gases, as a power source. Use filtered, lubricated, regulated compressed air only. Use of a reactive gas instead of compressed air may cause the nailer to explode which will cause death or serious personal injury.

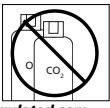

- Use only a pressure-regulated compressed air source to limit the air pressure supplied to the tool. The regulated pressure must not exceed 100 psi. If the regulator fails, the pressure delivered to the tool must not exceed 200 psi. The nailer could explode which will cause death or serious personal injury.

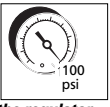

- Never use gasoline or other flammable liquids to clean the nailer. Never use the



nailer in the presence of flammable liquids or gases. Vapors could ignite by a spark and cause an explosion which will result in death or serious personal injury.

- Always remain in a firmly balanced position when using or handling the nailer.



- Do not remove, tamper with, or otherwise cause the Work Contact Element (WCE) or trigger to become inoperable. Do not operate any tool which has been modified in a like fashion. Death or serious personal injury could result.

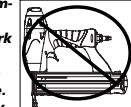

- Do not touch the trigger unless driving nails. Never attach air line to nailer or carry nailer while touching the trigger. The tool could eject a fastener which will result in death or serious personal injury.

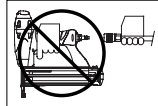

⚠ WARNING Warning indicates a potentially hazardous situation which, if not avoided, COULD result in death or serious injury.

- Always disconnect the tool from the power source when unattended, performing any

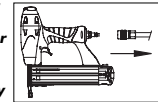

maintenance or repair, clearing a jam, or moving the tool to a new location. Always reconnect the air line BEFORE loading any fasteners. Do not load the tool with fasteners when either the trigger is depressed or the Work Contact Element (WCE) is engaged. The nailer could eject a fastener causing death or serious personal injury.

- Always fit tool with a fitting or hose coupling on or near the tool in such a manner that all compressed air in the tool is discharged at the time the fitting or hose coupling is disconnected. Do not use a check valve or any other fitting which allows air to remain in the nailer. Death or serious personal injury could occur.

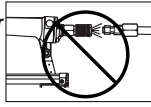

- Never place hands or any other body parts in the nail discharge area of the nailer. The nailer might eject a fastener and could result in death or serious personal injury.



- Never carry the nailer by the air hose or pull the hose to move the nailer or a compressor. Keep hoses away from heat, oil and sharp edges. Replace any hose that is damaged, weak or worn. Personal injury or tool damage could occur.



Nailer Components and Specifications

- **REQUIRES:** 0.8 SCFM with 10 nails per minute @ 90 PSI
- **AIR INLET:** 1/4" NPT
- **NAIL SIZE RANGE:** 3/8" to 1-1/4"
- **MAGAZINE CAPACITY:** 100 Nails per load, 18 gauge
- **WEIGHT:** 2 lb., 15 oz.
- **LENGTH:** 10"
- **HEIGHT:** 9"
- **MAXIMUM PRESSURE:** 100 PSI
- **PRESSURE RANGE:** 60 – 100 PSI

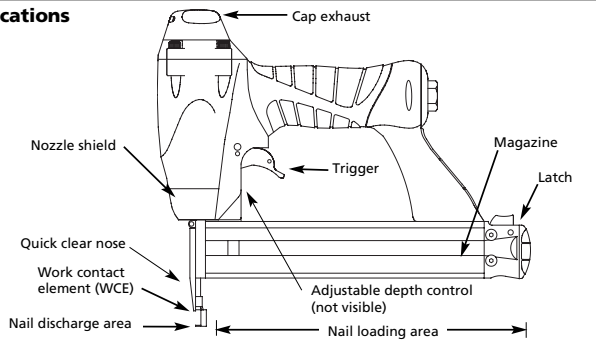

Troubleshooting Guide

⚠ WARNING Stop using nailer immediately if any of the following problems occur. Serious personal injury could result. Any repairs or replacements must be done by a Qualified Service Person or Authorized Service Center.

| Problem | Cause | Solution |
|---------------------------------------|---|---|
| Air leaking at trigger valve | O-Rings in trigger valve housing are damaged | Replace O-Rings. Check operation of Work Contact Element (WCE) |
| Air leaking between housing and nose | Damaged O-Rings Damage to bumper | Replace O-Rings Replace bumper |
| Air leaking between housing and cap | Loose screws Damaged gasket | Tighten screws Replace gasket |
| Nailer skips driving nail | Worn bumper Dirt in nose piece Dirt or damage prevent nails or pusher from moving freely in magazine | Replace bumper Clean drive channel Clean magazine |
| | Damaged pusher spring Inadequate air flow to nailer Worn O-Ring on piston or lack of lubrication | Replace spring Check fitting, hose or compressor Replace and lubricate O-Rings |
| | Damaged O-Ring on trigger valve Air leaks Cap gasket leaking | Replace O-Rings Tighten screws and fittings Replace gasket |
| Nailer runs slow or has loss of power | Nailer not lubricated sufficiently Broken spring in cylinder cap Exhaust port in cap is blocked | Lubricate nailer Replace spring Replace damaged internal parts |
| Nails are jammed in nailer | Guide on driver is worn Nails are not correct size Nails are bent Magazine or nose screws are loose Driver is damaged | Replace guide Use only recommended nails Replace with undamaged nails Tighten screws Replace driver |

Fasteners

MXN10100 can use 3/8" to 1-1/4" 18 gauge brad nails designed for the following tools:

- Bostitch® BT125SK-2
- DeWalt® D51238K
- Paslode® T125-F18
- Senco® Finish Pro™ 15
- Campbell Hausfeld® NB0030
- Hitachi® NT32AE
- Porter Cable® BN125

General Safety Information (Continued)

- **Always assume the nailer contains nails. Respect the tool as a working implement; no horseplay. Always keep others at a safe distance from the work area in case of accidental discharge of nails. Do not point the tool toward yourself or anyone whether it contains fasteners or not. Accidental triggering of the nailer could result in death or serious personal injury.**
- **Do not drive a nail on top of other nails. The nail could glance and cause death or a serious puncture wound.**
- **Do not operate or allow anyone else to operate the nailer if any warnings or warning labels are not legible. Warnings or warning labels are located on the nailer magazine and body.**
- **Do not drop or throw the tool. Dropping or throwing the tool can result in damage that will make the tool unusable or unsafe. If the tool has been dropped or thrown, examine the tool closely for bent, cracked or broken parts and air leaks. STOP and repair before using or serious injury could occur.**



CAUTION Caution indicates a potentially hazardous situation which, if not avoided, MAY result in minor or moderate injury.

- **Do not make any modifications to the tool without first obtaining written approval from Campbell Hausfeld. Do not use the nailer if any shields or guards are removed or altered. Do not use the nailer as a hammer. Personal injury or tool damage may occur.**
 - **Avoid long extended periods of work with the nailer. Stop using the nailer if you feel pain in hands or arms.**
 - **Always check that the Work Contact Element (WCE) is operating properly. A nail could accidentally be driven if the WCE is not working properly. Personal injury may occur (See "Checking the Work Contact Element" Section).**
 - **Disconnect air supply and release tension from the pusher before attempting to clear jams because fasteners can be ejected from the front of the nailer. Personal injury may occur.**
- NOTICE** Notice indicates important information, that if not followed, MAY cause damage to equipment.
- **Avoid using the nailer when the magazine is empty. Accelerated wear on the nailer may occur.**
 - **Clean and check all air supply hoses and fittings before connecting the nailer to an air supply. Replace any damaged or worn hoses or fittings. Tool performance or durability may be reduced.**

Operating The Nailer

RECOMMENDED HOOKUP

The illustration below shows the recommended hookup for the nailer.

1. The air compressor must be able to maintain a minimum of 60 psi when the nailer is being used. An inadequate air supply can cause a loss of power and inconsistent driving.
2. Always use air supply hoses with a minimum working pressure rating equal to or greater than the pressure from the power source if a regulator fails, or 150 psi, whichever is greater. Use 3/8" air hose for runs up to 50'. Use 1/2" air hoses for 50' run or longer. For better performance, install a 3/8" quick plug (1/4" NPT threads) with an inside diameter of .315" (8mm) on the nailer and a 3/8" quick coupler on the air hose.

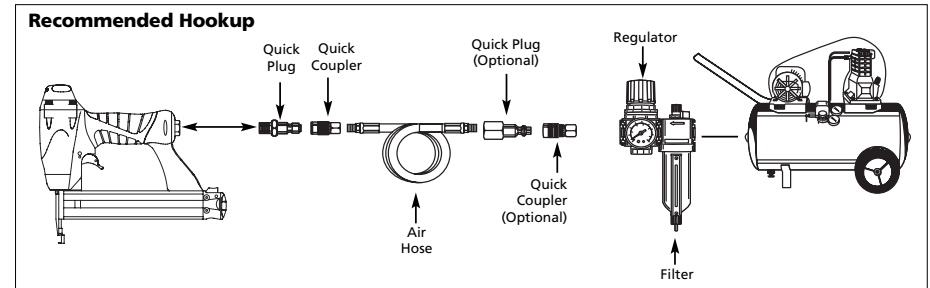
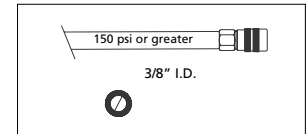
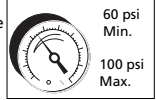

Operating The Nailer

(Continued)

- Use a pressure regulator on the compressor, with an operating pressure of 0 - 125 psi. A pressure regulator is required to control the operating pressure of the nailer between 60 and 100 psi.

OPERATIONAL MODE

AWARNING Always know the operational mode of the nailer before using. Failure to know the operational mode could result in death or serious personal injury.

SINGLE SEQUENTIAL MODE

This mode requires the trigger to be pulled each time a nail is driven. The nailer can be actuated by depressing the Work Contact Element (WCE) against the work surface followed by pulling the trigger.

The trigger must be released to reset the tool before another nail can be driven.

OPERATING A SEQUENTIAL TRIP NAILER

CAUTION Check the operation of the Work Contact Element (WCE) trip mechanism before each use. The WCE must move freely without binding through its entire travel distance. The WCE spring must return the WCE to its fully extended position after being depressed. Do not operate the nailer if the WCE trip mechanism is not operating properly. Personal injury may occur.

- Disconnect the air supply from the nailer.
- Remove all nails from the magazine (see Loading/Unloading).

- Make sure the trigger and work contact element (WCE) move freely up and down without sticking or binding.

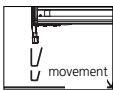

- Reconnect air supply to the nailer.

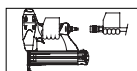

- Depress the Work Contact Element (WCE) against the work surface without pulling the trigger. The nailer **MUST NOT OPERATE**. Do not use the tool if it operates without pulling the trigger. Personal injury may result.

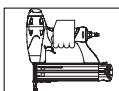

- Remove the nailer from the work surface. The Work Contact Element (WCE) must return to its original down position. The nailer **MUST NOT OPERATE**. Do not use the tool if it operates while lifted from the work surface. Personal injury may result.

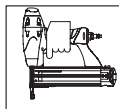

- Pull the trigger and depress the work contact element (WCE) against the work surface. The nailer **MUST NOT OPERATE**.

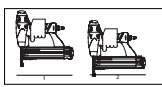

- Depress the Work Contact Element (WCE) against the work surface. Pull the trigger. The nailer **MUST OPERATE**.

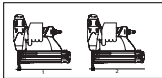

AWARNING An improperly functioning tool must not be used. Do not actuate the tool unless the tool is placed firmly against the work piece.

LOADING/UNLOADING THE NAILER

- Always **connect** the tool to the air supply **before** loading fasteners.
- Push down on the latch. Pull back on the magazine cover.
- Insert a stick of Campbell Hausfeld nails or equivalent (see "Fasteners" section) into the magazine. Make sure the pointed ends of the nails are resting on the bottom ledge of the magazine when loading. Make sure the nails are not dirty or damaged.
- Push the magazine cover forward until the latch catches.
- Always unload all fasteners before removing tool from service. Unloading is the reverse of loading, except always disconnect the air supply before unloading.

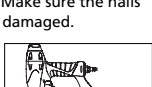
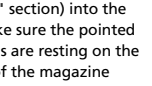
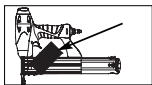
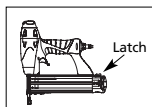

ADJUSTING THE NAIL PENETRATION

The nailer is equipped with an adjustable depth of drive feature. This allows the user to determine how deep a fastener will be driven into the work surface.

- Adjust operating pressure so nails are driven consistently. Do not exceed 100 psi.
- To drive the nail shallower, turn the wheel (C) to right to the extent desired.
- To sink a nail deeper, turn the wheel (C) to left to the extent desired.

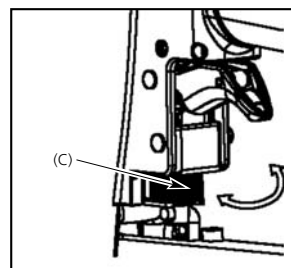

Operating The Nailer

(Continued)

- Make sure trigger and work contact element (WCE) move freely up and down without binding or sticking after each adjustment.

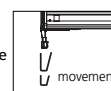

ADJUSTING THE DIRECTION OF THE EXHAUST

The nailer is equipped with an adjustable direction exhaust deflector. This is intended to allow the user to change the direction of the exhaust. Simply twist the deflector to any direction desired.

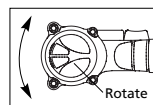

CLEARING A JAM FROM THE NAILER

- Disconnect the air supply from the nailer.
- Remove all nails from the magazine (see Loading/Unloading).

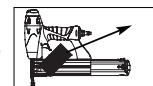
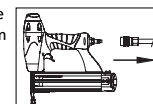

AWARNING Failure to remove all fasteners will cause the fasteners to eject from the front of the tool.

- Undo hook by pushing down on the button on the side of the magazine. The button will disengage the hook from the nose.

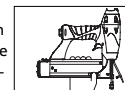

- The door can now be rotated, exposing the jammed fastener.

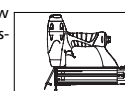

- Remove the jammed fastener, using pliers or a screwdriver if required.

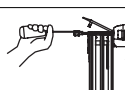

- Rotate door back into the closed position.

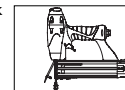

- Push button down again to lift the hook. Close the door and release the button to reengage the hook with the nose.

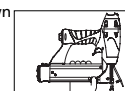

- Make sure the trigger and work contact element (WCE) move freely up and down without sticking or binding.

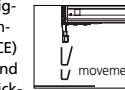

Technical Support

Please call our Nailer Hotline at 1-888-241-5858 with any questions regarding the operation or repair of this nailer or for additional copies of this manual.

Fastener And Replacement Parts

AWARNING Use only genuine Campbell Hausfeld 18 gauge fasteners (or equivalent - see Fastener Interchange Information). Tool performance, safety and durability could be reduced if improper fasteners are used. When ordering replacement parts or fasteners, specify by part number.